

③ PT. $(w^R)^R = w \quad \forall w \in \Sigma^*$

(Induction)

$$(uw)^R = u^R u^R$$

(n-1) length: $u = wa$

$$(uwa)^R = (wa)^R u^R \\ = aw^R u^R$$

\therefore true $\forall w \in \Sigma^*$

④ $L = \{ab, aa, baa\}$

which of the following strings are in L^*, L^+ ?

abaabaabaa L^+, L^*

aaaabaaaa L^+, L^*

baaaaabaaaaab

baaaaabaa L^+, L^*

⑤ let $\Sigma = \{a, b\}$ Use set notation to describe \bar{L} .

$$L = \{aa, bb\}$$

$$\bar{L} = \Sigma - \{aa, bb\}$$

$$L = \{\lambda, a, b, ab, ba\} \cup \{w : |w| > 2, w \in \Sigma^*\}$$

⑥ let L be any language on a non-empty alphabet. show that L, \bar{L} cannot be both finite.

Case (i) L is finite

\rightarrow we know Σ is infinite

$$\rightarrow \bar{L} = \Sigma - L$$

= infinite lang - finite lang

= infinite lang.

Case (ii) L is infinite

Σ is infinite

$$\bar{L} = \Sigma - L$$

= finite

From above, in any case, both cannot be

finite

7) Are there any languages for which $\overline{L^*} = (\overline{L})^*$?

$$\lambda \in L^*$$

$$\Rightarrow \lambda \notin \overline{L^*}$$

but $(\overline{L})^*$ contains λ

\therefore No language satisfies $\overline{L^*} = (\overline{L})^*$

8) Pt. $(L_1 L_2)^R = L_2^R L_1^R \neq L_1 L_2$

let $u \in L_1, v \in L_2$

$$L_1 L_2 \Rightarrow uv$$

$$(L_1 L_2)^R \Rightarrow (uv)^R$$

$$= v^R u^R = L_2^R L_1^R \neq L_1 L_2$$

$$\therefore (L_1 L_2)^R = L_2^R L_1^R \neq L_1 L_2$$

9) Show that $(L^*)^* = L^* \neq L$.

let $\Sigma = \{a, b\}$

$$L^* \Rightarrow \Sigma^* \Rightarrow \{a, b\}^*$$

$$(L^*)^* \Rightarrow (\{a, b\}^*)^* = \{a, b\}^* \\ = L^* \neq \Sigma$$

10) (a) $(L \cup L_2)^R = L^R \cup L_2^R \neq L_1 L_2$

$(L \cup L_2)^R \Rightarrow$ If $u \in L, v \in L_2$

$$uv \in L \cup L_2,$$

$$(L \cup L_2)^R = (uv)^R = v^R u^R \\ \neq L_1^R \cup L_2^R$$

(EXERCISES)

10. (b)

$$(L^R)^* = (L^*)^R \neq L$$

let $uv \in L$

$$L^R = (uv)^R = v^R u^R$$

$$(L^R)^* = (v^R u^R)^*$$

$$L^* = (uv)^*$$

$$(L^*)^R = [(uv)^*]^R$$

$$\therefore (L^R)^* \neq (L^*)^R$$

11. Find the Grammars that generate the sets of following for $\Sigma = \{a, b\}$

(a) all strings with exactly one a.

P:

$$S \rightarrow AaA \\ A \rightarrow bA/\lambda$$

$$G = (\{A, S\}, \{a, b\}, S, P)$$

(b) all strings with atleast one a.

P:

$$S \rightarrow AaA \\ A \rightarrow aA/bA/\lambda$$

$$G = (\{A, S\}, \Sigma, S, P)$$

(c) all strings with no more than 3 a's.

P:

$$S \rightarrow AaAaAaA \quad 0,1,2,3 \text{ a's} \\ A \rightarrow bA/\lambda$$

$$G = (\{A, S\}, \Sigma, S, P) \quad S \rightarrow AaA/bAaA/\lambda \\ AaAaAaA \quad A \rightarrow bA/\lambda$$

(d) all strings with atleast 3 a's.

P:

$$S \rightarrow AaAaAaA \\ A \rightarrow aA/bA/\lambda$$

$$G = (\{A, S\}, \Sigma, S, P)$$

Test:

aaa: $S \rightarrow AaAaAaA \rightarrow aaa$

baababa: $S \rightarrow AaAaAaA \rightarrow baAaAaA \rightarrow$

$baaAaAaA \rightarrow baabaAaA \rightarrow$

$baababa \checkmark$

$S \rightarrow AaA/bAaA/\lambda$
 $A \rightarrow bA/\lambda$

12

$$S \rightarrow aA$$

$$A \rightarrow bS$$

$$S \rightarrow \lambda$$

ab, abab, ...

$$L = \{(ab)^n : n \geq 0\}$$

13

What language does the Grammar with these productions generate?

$$S \rightarrow Aa$$

$$A \rightarrow B$$

$$B \rightarrow Aa$$

$$S \rightarrow Aa \rightarrow Ba \rightarrow Aaa$$

$L = \emptyset$ \because no terminal symbol to generate strings.

14

$\Sigma = \{a, b\}$. For each of below languages, find a grammar that generates it

(a) $L_1 = \{a^n b^m : n \geq 0, m > n\}$

P₁:

$$S \rightarrow Ab$$

$$A \rightarrow aAb / \lambda / Ab$$

$$G: (\{A, S\}, \{a, b\}, S, P_1)$$

test: $b: S \rightarrow Ab \rightarrow b \checkmark$

$$abb \rightarrow Ab \rightarrow aAbb \rightarrow abb \checkmark$$

$ab: S \rightarrow Ab \times$

$$bb \rightarrow S \rightarrow Ab \rightarrow bb \checkmark$$

$S \rightarrow aSb / B$
 $B \rightarrow bB / b$

(b)

$$L_2 = \{a^n b^{2n} : n \geq 0\}$$

P₂:

$$S \rightarrow aSbb / \lambda$$

$$G: (\{S\}, \Sigma, S, P_2)$$

test:

$\lambda: S \rightarrow \lambda \checkmark$

$aab: S \rightarrow aSbb \times$

$abb: S \rightarrow aSbb \rightarrow abb \checkmark$

(c)

$$L_3 = \{a^{n+2} b^n : n \geq 1\}$$

$$S \rightarrow aaA$$

$$A \rightarrow aAb / \lambda$$

test:

$n=1: a^3 b^1: S \rightarrow aaA \rightarrow aaAaB \rightarrow aaab$

14.

(c)

$$L_4 = \{a^n b^{n-3} : n \geq 3\}$$

$$n-3 = m$$

$$n = m+3$$

$$n \geq 3$$

$$m \geq 0$$

$$\Rightarrow L_3 = \{a^{m+3} b^m : m \geq 0\}$$

P₃:

$$S \rightarrow aaaA$$

$$A \rightarrow aSb/\lambda$$

$$\therefore G = (\{A, S\}, \Sigma, S, P_3)$$

(d)

$$L_3 = L_1 L_2$$

$$L_5 = \{a^n b^m a^n b^{2n} : n \geq 0, m > n\}$$

$$= \{a^n b^m a^k b^{2k} : n, k \geq 0, m > n\}$$

$$S \rightarrow AB$$

$$A \rightarrow Cb$$

$$C \rightarrow aCb/\lambda/Cb$$

$$B \rightarrow aBbb/\lambda$$

$$S \rightarrow AbB$$

$$A \rightarrow aAb/\lambda/Ab$$

$$B \rightarrow aBbb/\lambda$$

$$S \rightarrow S_1 S_2$$

$$\underline{\text{t \& t}}: \text{abbabb} : S \rightarrow AbB \rightarrow aAbB \rightarrow abbB \rightarrow \text{abbabb} \checkmark$$

$$b : S \rightarrow AbB \rightarrow bB \rightarrow b \checkmark$$

$$bb : \times$$

(e) $L_1 \cup L_2$:

$$S \rightarrow Ab/B$$

$$A \rightarrow aAb/\lambda$$

$$B \rightarrow aBbb/\lambda$$

$$S \rightarrow S_1/S_2$$

(g)

$$L_3: \{a^n b^m a^n b^m a^n b^m : n \geq 0, m > n\}$$

$$S \rightarrow AbAbAb$$

$$A \rightarrow aAb / Ab / \lambda$$

$$S \rightarrow SSS_1$$

Test: $n=0, m=1$ bbb

$$S \rightarrow AbAbAb \rightarrow bbb$$

reject: abababa

$$S \rightarrow AbAbAb$$

$$\rightarrow aAbbAbAb \quad \times$$

$n=0, m=2$ bbbbbb

$$S \rightarrow AbAbAb \rightarrow bbbbbb$$

(h)

$$L_1^*: L_1 = \{a^n b^m : n \geq 0, m > n\}$$

$$S \rightarrow SA / \lambda$$

$$A \rightarrow aAb / Ab / \lambda$$

$$S \rightarrow SSS_1 / \lambda$$

test: $\lambda: S \rightarrow \lambda$

$$\text{abbaabbb: } S \rightarrow SA \rightarrow SaAb \rightarrow Sa aAbb \rightarrow Sa aabbb \rightarrow$$

$$SA aabbb \rightarrow aAbaabbb \rightarrow \text{abbaabbb} \quad \checkmark$$

reject:

$$\text{aba: } S \rightarrow SA \rightarrow SaAb \quad \times$$

(i)

$$L_1 - \overline{L_4} :$$

$$L_4 = \{a^{n+3} b^m : n \geq 0\}$$

$$L_1 = \{a^n b^m : n \geq 0, m > n\}$$

$$L_1 - \overline{L_4} = L_1 - (U - L_4)$$

$$= L_1 - U + L_4$$

$$= L_1 + L_4 - U = \emptyset$$

15

Find the grammars for the following on $\Sigma = \{a,b\}$

(a) $L = \{w : |w| \bmod 3 = 0\}$

$S \rightarrow aaaS / \lambda$

(b) $L = \{w : |w| \bmod 3 > 0\}$

$S \rightarrow A / B$

1, 2, 4, 5, 7, 8, 10, 11

$A \rightarrow aaaS / a$

$S \rightarrow aaaS / a / aa$

$B \rightarrow aaaS / aa$

Test:

aaaaaaaa: $S \rightarrow A \rightarrow aaaS \rightarrow aaaSaaS \rightarrow aaaaaaaaa$

aaaaaaaaaa: X

(c) $L = \{w : |w| \bmod 3 \neq |w| \bmod 2\}$

mod 3
↓
{0, 1, 2}

mod 2
↓
{0, 1}

#	mod 2	mod 3
0	0	0
1	1	1
2	0	2
3	1	0
4	0	1
5	1	2
6	0	0
7	1	1

→ skip every 6th & 7th

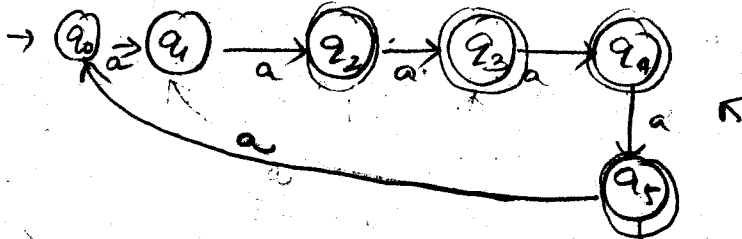

8	0	2
9	1	0
10	0	1
11	1	2
12	0	0
13	1	1
14	0	2

$S \rightarrow aaA$

$S \rightarrow aa / aaaS / aaaSaaS / aaaSaaSaaS$

$A \rightarrow \lambda / a / aaaS / aaaSaaS$

Test:

λ X 9a's ✓
a X 8a's ✓
aa ✓ 13a's X

$S \rightarrow aaA$
 $A \rightarrow \lambda / a / aaaS / aaaSaaS$

(d) $L = \{w : |w| \bmod 3 \geq |w| \bmod 2\}$

$ w $	$\bmod 2$	$\bmod 3$	\geq
0	0	0	✓
1	1	1	✓
2	0	2	✓
3	1	0	✗
4	0	1	✓
5	1	2	✓
6	0	0	✓
7	1	1	✓
8	0	2	✓
9	1	0	✗
10	0	1	✓
11	1	2	✓
12	0	0	✓
13	1	1	✓
14	0	2	✓
15	1	0	✗

$S \rightarrow \lambda / a / aa / aaa A$
 $A \rightarrow a / aa / aaa / aaaa / aaaaa / aaaaaa A$

Test: 3a's: $S \rightarrow aaa A$ ✗
 5a's: $S \rightarrow aaaa \rightarrow aaaaa$ ✓

(16) Find a grammar that generates the language $L = \{ww^R : w \in \{a,b\}^+\}$

$S \rightarrow aSa / bSb / a / b$ $\{a,b\}^+$

abba : $S \rightarrow aSa \rightarrow absba \rightarrow abba$
 bbbb : $S \rightarrow bSb \rightarrow bbsbb \rightarrow bbbb$
 $S \rightarrow a / b$

(17) Give verbal description of

$S \rightarrow aSb / bSa / a$

In no order of a and b, no. of a's ^{one} a_{n+1} more in any string.

$S \rightarrow aSb \rightarrow aaSbb \rightarrow aaabb$
 $\rightarrow bSa \rightarrow baa$
 $bSa \rightarrow bbsaa \rightarrow bbaaa$

b's : n
 a's : n+1

18

(a) $L = \{w : n_a(w) = n_b(w) + 1\}$

we know for $L = \{w : n_a(w) = n_b(w)\}$

equal a's & b's

$G \Rightarrow S \rightarrow SS$

$S \rightarrow asb / bSa / \lambda$

$A \rightarrow AA / aAb / bAa / \lambda$

$S \rightarrow \boxed{AaA}$

↑
additional A

$\therefore S \rightarrow Ssa / aSS / aSb / bSa / (\lambda) / SaS$

Test:

$S \rightarrow Ssa \rightarrow asbSa \rightarrow a\lambda b\lambda a \rightarrow aba \rightarrow \boxed{aba} \checkmark$

$S \rightarrow \boxed{a} \checkmark$

$S \rightarrow Ssa \rightarrow asbbSaa \rightarrow a\lambda bb\lambda a a \rightarrow \boxed{abb aa} \checkmark$

$S \rightarrow Ssa \rightarrow bSaa \rightarrow bbSaaa \rightarrow bbbSaaaa \rightarrow \boxed{bbb aaaa} \checkmark$

$S \rightarrow SaS \rightarrow bSaa asb \rightarrow \boxed{baaab} \checkmark$

(b) $L = \{w : n_a(w) > n_b(w)\}$ $S \rightarrow SS / asb / bSa / aS/a$ add any no. of a's

$S \rightarrow SS / \cancel{aS} / asb / bSa / (\lambda)$

(c) $L = \{w : n_a(w) = 2 n_b(w)\}$

$S \rightarrow SS / aSba / aaSb / bSaa / abSa / aSab / baSa / \lambda$

test: reject $aabb$: $aasb \rightarrow aab \times$

$aaab$: $aasb \rightarrow aa \times$

aab : $S \rightarrow aab \checkmark$

ababbbaaa : $S \rightarrow SS \rightarrow abSa \rightarrow ababSaa \rightarrow ababbaSaaa$

$\rightarrow \underline{ababbbaaaa} \checkmark$

$aaaaaabbb$: $SS \rightarrow aasb \rightarrow aaaaSbb$

$\rightarrow aaaaaaSbbb \rightarrow \underline{aaaaaabbbb} \checkmark$

(d) $L = \{w \in \{a,b\}^* : |n_a(w) - n_b(w)| = 1\}$ Equal as $2b's$

~~$\rightarrow n_a(w) = n_b(w) + 1$
 $n_b(w) = n_a(w) + 1$~~

~~$A \rightarrow AA/aAb/bAa/\lambda$~~

~~$S \rightarrow AaA/ABa$~~

$S \rightarrow A/B$

$A \rightarrow AAa/aAA/AaA/aAb/bAa/\lambda$

$B \rightarrow BBb/bBB/BbB/aBb/bBa/\lambda$

(19)

$\Sigma = \{a,b,c\}$

(a) $L = \{w : n_a(w) = n_b(w) + 1\}$

we know for

$\Sigma = \{a,b\}$

$n_a(w) = n_b(w)$

$S \rightarrow SS/aSb/bSa/\lambda$

$a=b : c \text{ varying}$

$S \rightarrow SS/aSb/bSa/cS/\lambda$

$a=b+1 : c \text{ varying}$

$S \rightarrow AaA$

$A \rightarrow AA/aAb/bAa/cA/\lambda$

$\therefore \Sigma = \{a,b,c\} : S \rightarrow SS/aSb/bSa/C$

$C \rightarrow cC/\lambda$

~~$S \rightarrow AaA$
 $A \rightarrow aAb/bAa/c$
 $C \rightarrow cC/\lambda$~~

$\therefore n_a(w) = n_b(w) + 1 \Rightarrow$

$S \rightarrow aSS/SSa/saS/aSb/bSa/C$

$C \rightarrow cC/\lambda$

(or) $S \rightarrow SSa/aSS/saS/aSb/bSa/cS/\lambda$

(b) $L = \{w : n_a(w) \geq n_b(w)\}$

$S \rightarrow SS/aSb/bSa/aS/aS/\lambda$

$S \rightarrow SS/aS/aSb/bSa/cS/\lambda$

(c) $L = \{w : n_a(w) = 2n_b(w)\}$

$S \rightarrow SS/cS/aSb/asba/aSab/abSa/baSa/bSaa/\lambda$

(d) $L = \{w : |n_a(w) - n_b(w)| = 1\}$

~~$S \rightarrow S_1 S_2$ add one a/
add one b~~ $S \rightarrow AaA/AbA$
 $A \rightarrow aAb/bAa/AA$

~~$S_2 \rightarrow S_2 S_2 / cS_2 / baSb/abSb/bbSa/bSab/bSba/\lambda cA/\lambda$~~

CH #1-2
EXERCISES

PT. $S \rightarrow aAb / \lambda$
 $A \rightarrow aAb / \lambda$ generates $\{a^n b^n : n \geq 0\}$

$S \rightarrow \lambda$
 $S \rightarrow aAb \rightarrow ab$
 $S \rightarrow aAb \rightarrow aaAbb \rightarrow aabb$

$\therefore L = \{\lambda, ab, aabb, \dots\}$

$L = \{a^n b^n : n \geq 0\}$ is true

(21)

$S \rightarrow aSb / ab / \lambda$ \equiv $S \rightarrow aAb / ab$
 $A \rightarrow aAb / \lambda$

$S \rightarrow \lambda$
 $S \rightarrow ab$
 $S \rightarrow aSb \rightarrow aabb$

$S \rightarrow ab$
 $S \rightarrow aAb \rightarrow ab$
 $S \rightarrow aaAbb \rightarrow aabb$

$L = \{a^n b^n : n \geq 0\}$

$L = \{a^n b^n : n > 0\}$

as both grammars represent different languages,
they are not equivalent.

(22)

ST. $S \rightarrow SS / SSS / aSb / bSa / \lambda$ is equivalent to $S \rightarrow SS / aSb / bSa / \lambda$.

If we rewrite SS as SSS $\{ \text{or } S \rightarrow SS \}$

both are representing same Grammars.

where $n_a(w) = n_b(w)$

(23)

ST. $S \rightarrow aSb / bSa / SS / a$ \neq $S \rightarrow aSb / bSa / a$

$S \rightarrow a$
 $S \rightarrow SS \rightarrow aa$

$S \rightarrow aSb \rightarrow aab$

$aa \in L_1$

$aa \notin L_2$

CHAPTER 1-3

Example 1.15

- ① id is a sequence of letters, digits, underscores
- ② id must start with a letter or underscore
- ③ id allow upper & lower case letters.

$\langle id \rangle \rightarrow \langle letter \rangle \langle rest \rangle / \langle undscr \rangle \langle rest \rangle$

$\langle rest \rangle \rightarrow \langle letter \rangle \langle rest \rangle / \langle digit \rangle \langle rest \rangle / \langle undscr \rangle \langle rest \rangle / \lambda$

$\langle letter \rangle \rightarrow a|b|c| \dots |z / A|B|C| \dots |Z$

$\langle digit \rangle \rightarrow 0|1|2| \dots |9$

$\langle undscr \rangle \rightarrow -$

1.16

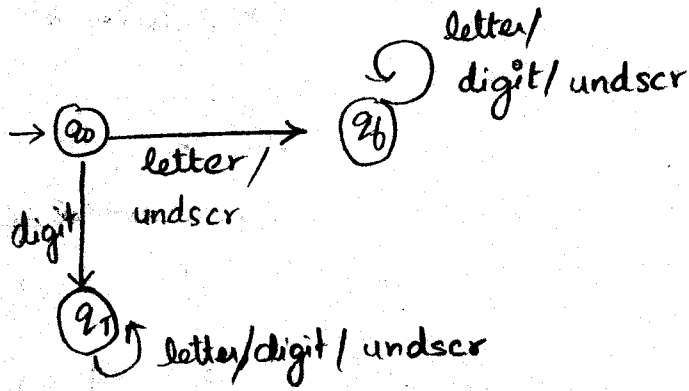

Example 1.17

Binary Adder

		b_i	
		0	1
a_i	0	No Carry	No Carry
	1	No Carry	Carry

$$V(x) = \sum_{i=0}^n a_i 2^i$$

$i/p : (a_i, b_i)$

$a/p = \text{sum bit } d_i$

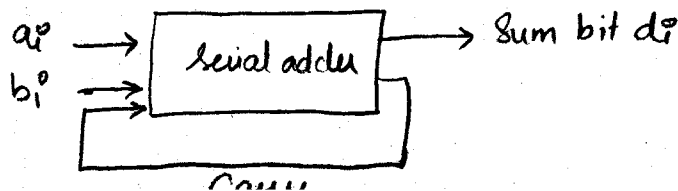

Example 2.3

Find a dfa that recognises all strings on $\Sigma = \{a,b\}$ with prefix ab.

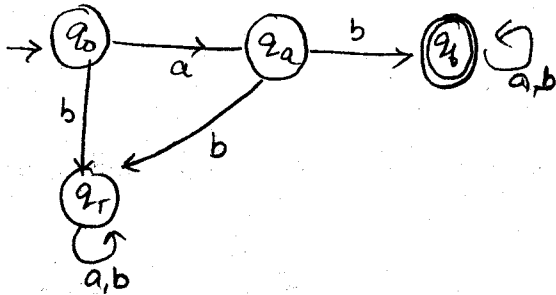

Example 2.4

Find a dfa that accepts all the strings on $\{0,1\}$ except those containing the substring 001.

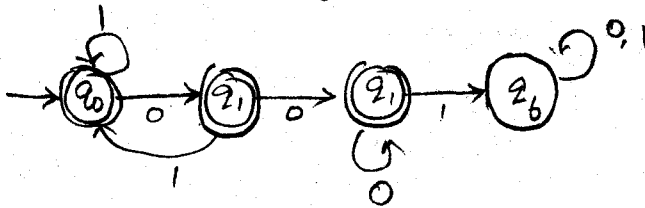

Example 2.5

Show that $L = \{awa : w \in \{a,b\}^*\}$ is regular.

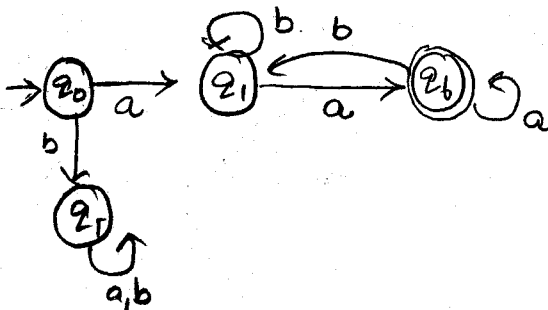

Show that Regular \Rightarrow Draw Dfa

Example 2.6

$L = \{aw_1aw_2a : w_1, w_2 \in \{a,b\}^*\}$ is regular.

L regular $\Rightarrow L^1, L^2, L^3, \dots$ are also regular.

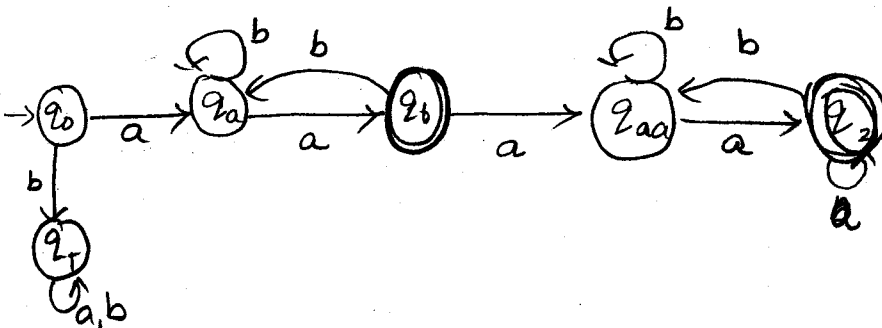

EXERCISES

① Which of following are accepted by

0001 ✓
01001 ✓

0000110. X

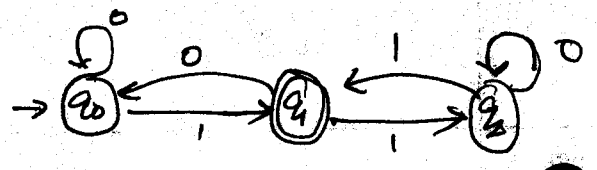

② For $\Sigma = \{a,b\}$ construct dfa's

(a) all strings with exactly one a.

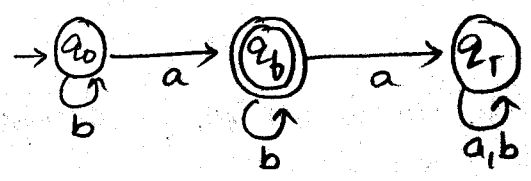

(b) all strings with @least one a

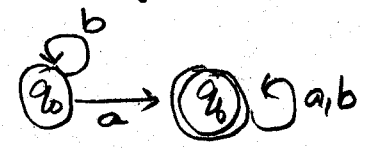

(c) all strings with no more than 3 a's.

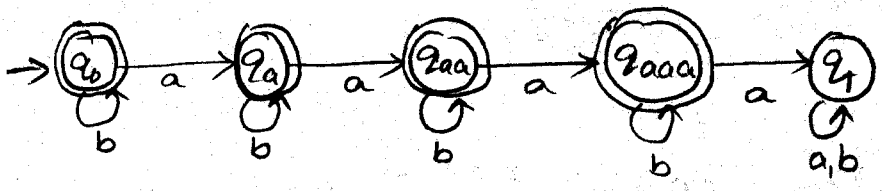

(d) @least one a & exactly 2 b's.

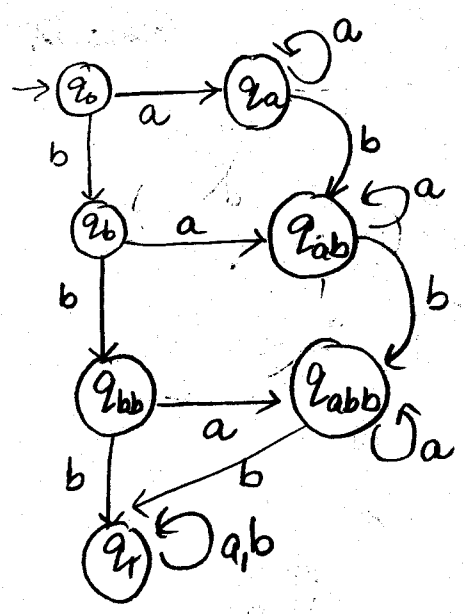

(e) all strings with 2 a's & more than 2 b's.

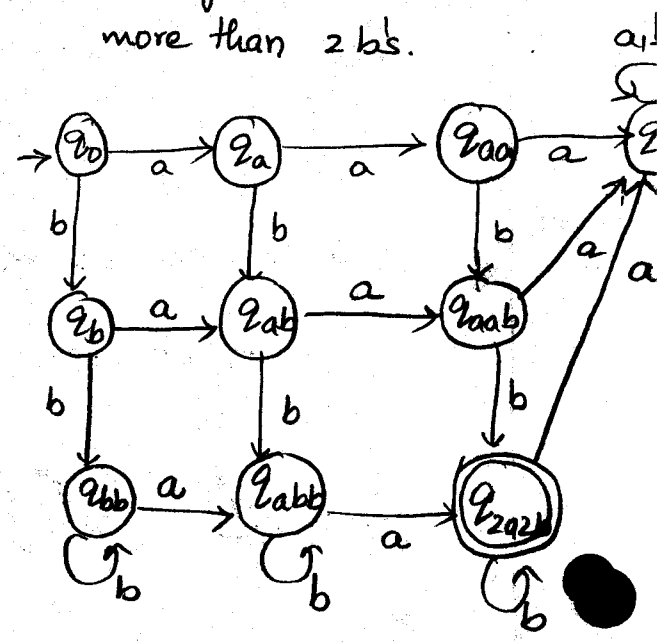

③

ST in

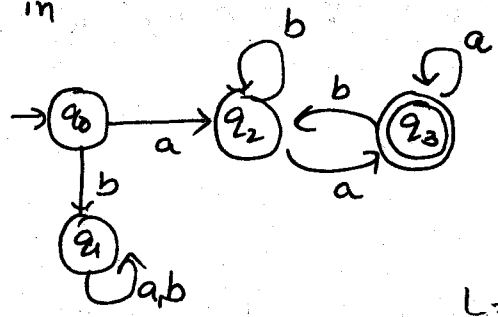

If: $q_3 \notin F$
 $q_0, q_1, q_2 \in F$, resulting dfa accepts \bar{L} .

$L = \{awa : w \in \Sigma^*\}$
 \bar{L} : is accepted by the changes to L .

④

$M = (Q, \Sigma, \delta, q_0, F)$

$\hat{M} = (Q, \Sigma, \delta, q_0, Q-F)$

then $\overline{L(M)} = L(\hat{M})$

⑤

(a) $L = \{ab^5wb^2 : w \in \{a,b\}^*\}$

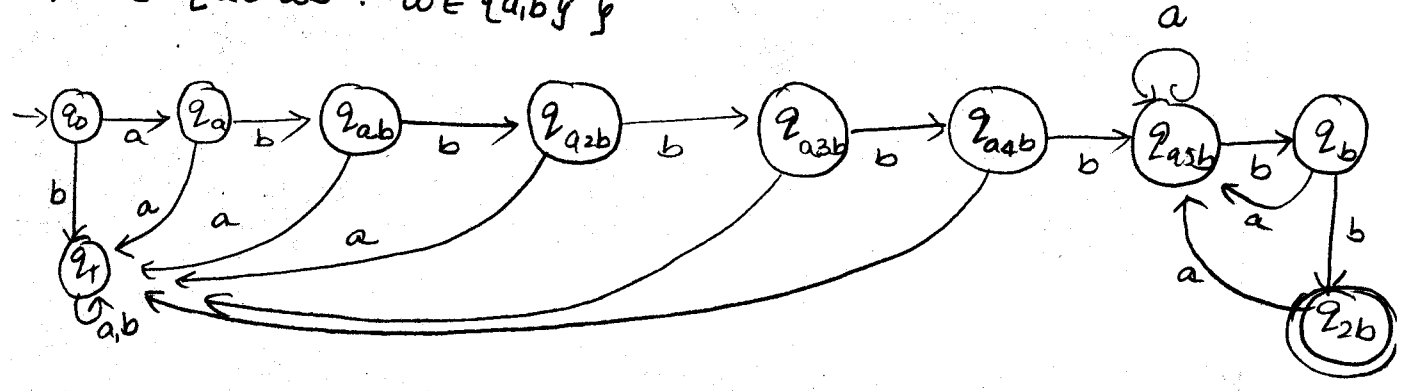

(b) $L = \{ab^n a^m : n \geq 2, m \geq 3\}$

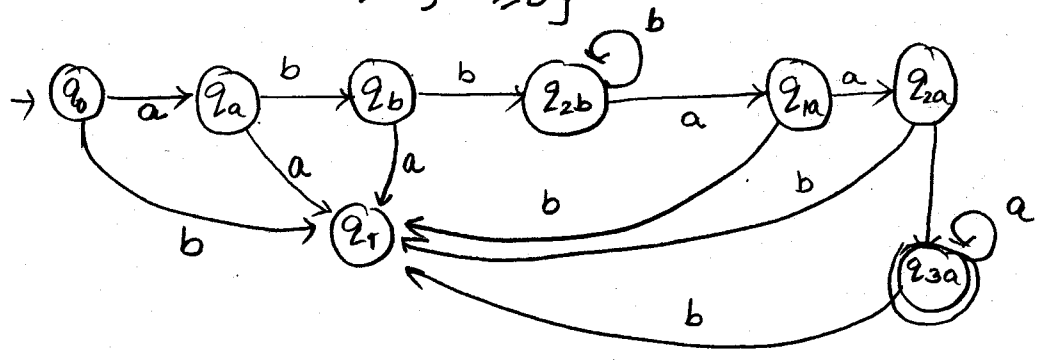

(c) $L = \{w_1abw_2 : w_1 \in \{a,b\}^+, w_2 \in \{a,b\}^*\}$

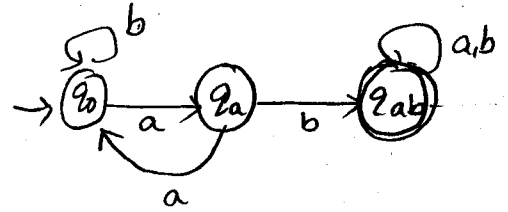

6) $\Sigma = \{a, b\}$ give dfa for $L = \{w_1 a w_2 : |w_1| \geq 3, |w_2| \leq 5\}$

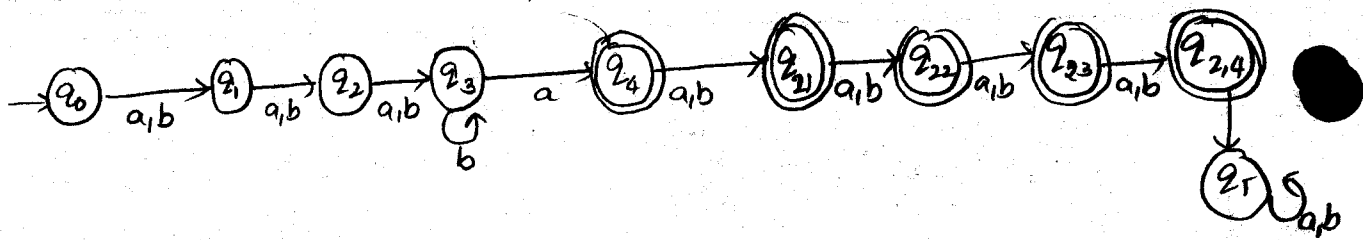

7) on $\Sigma = \{a, b\}$

(a) $L = \{w : |w| \bmod 3 = 0\}$

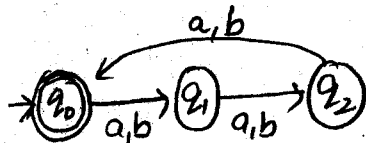

(b) $L = \{w : |w| \bmod 5 \neq 0\}$

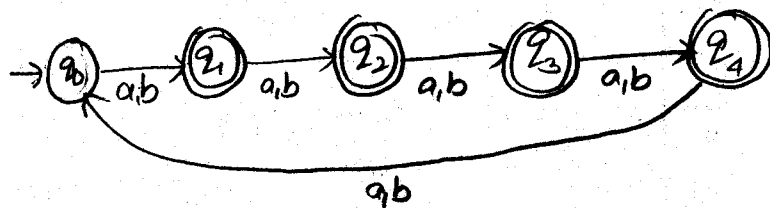

(c) $L = \{w : n_a(w) \bmod 3 > 1\}$

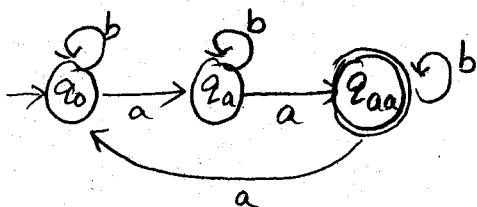

(d) $L = \{w : n_a(w) \bmod 3 > n_b(w) \bmod 3\}$

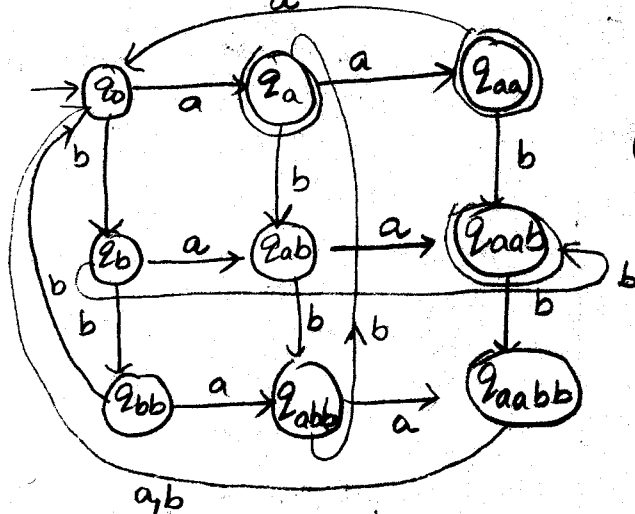

(e) $L = \{w : (n_a(w) - n_b(w)) \bmod 3 > 0\}$

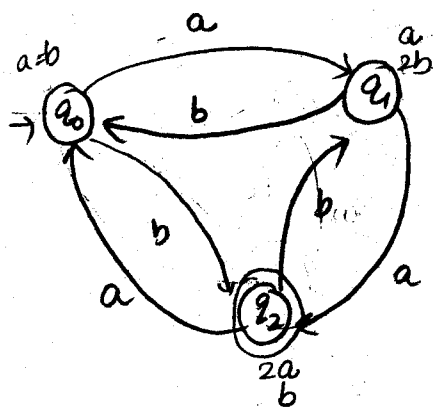

(f) $L = \{w : (n_a(w) + 2n_b(w)) \bmod 3 < 2\}$

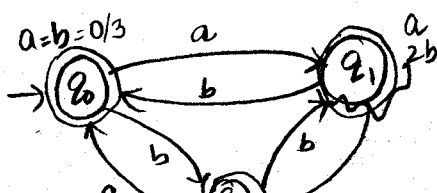

8

run = substring of length at least 2 & entirely of same symbol

on $\Sigma = \{a, b\}$ find dfa for

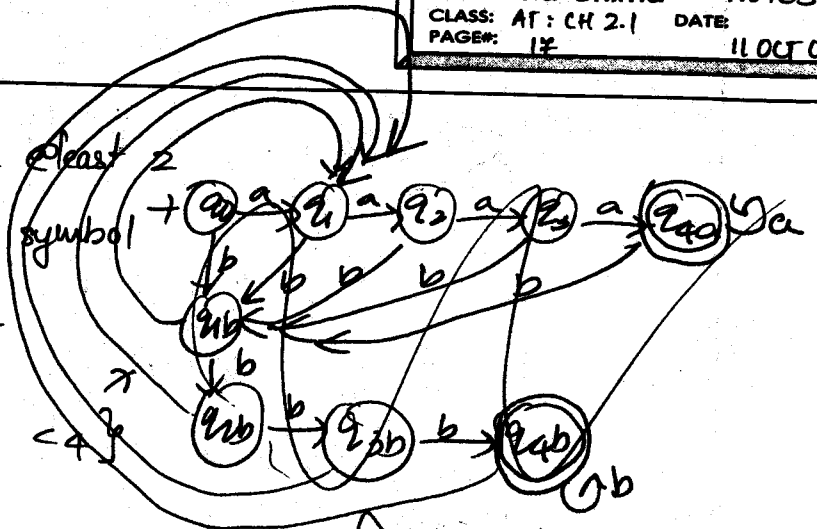

(a) $L = \{w : \text{no runs of length } < 4\}$

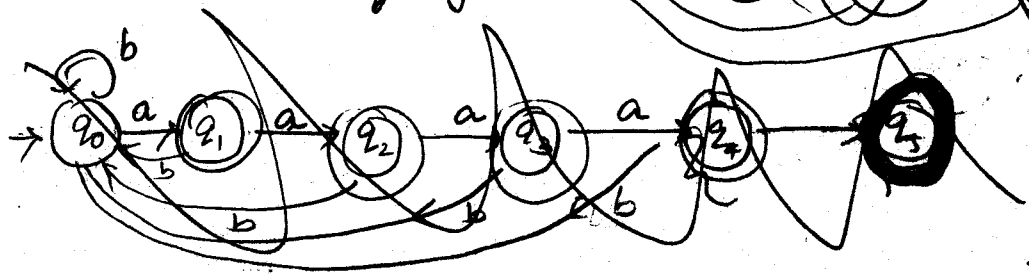

{ ϵ w, ϵ w a should be accepted also. implies one a accepted }

(b) $L = \{w : \text{every run of a's has length 2 or 3}\}$

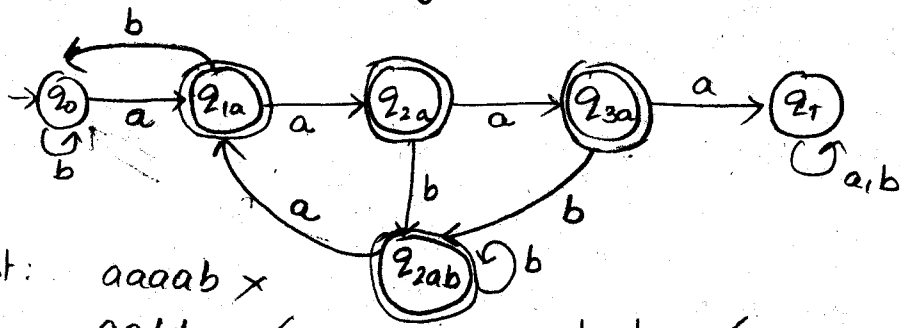

Test:
 aaaab x
 aabba ✓
 baaab ✓
 baba ✓
 baaaa x

(c) $L = \{w : \text{exactly 2 runs of a's of length 3}\}$
 waaaaw / waaaawaaaaw

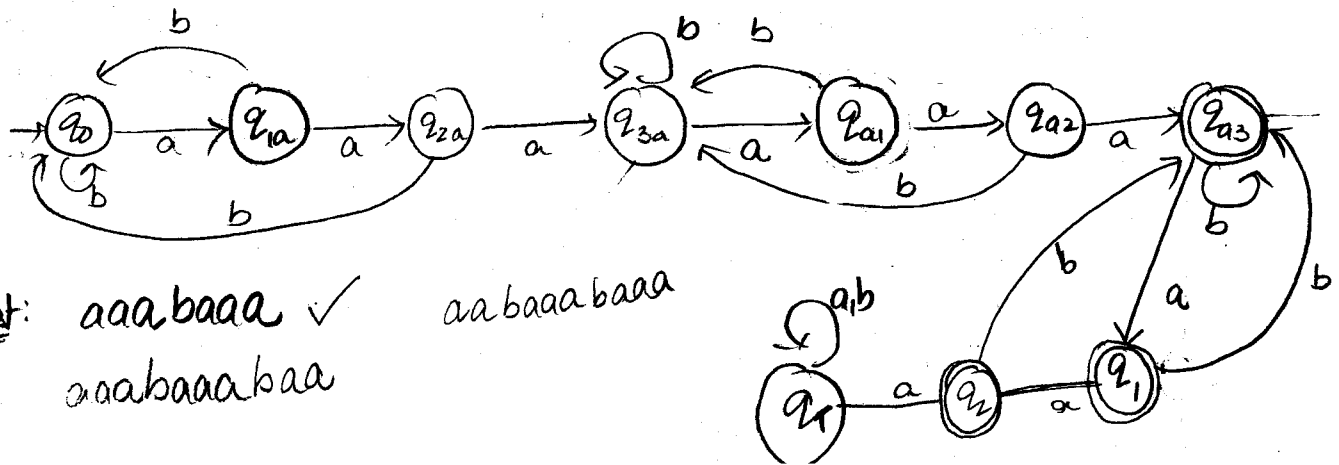

Test:
 aaabaaa ✓
 aaabaaaabaa

(d) $L = \{w: \text{@most 2 runs of a's of length 3}\}$

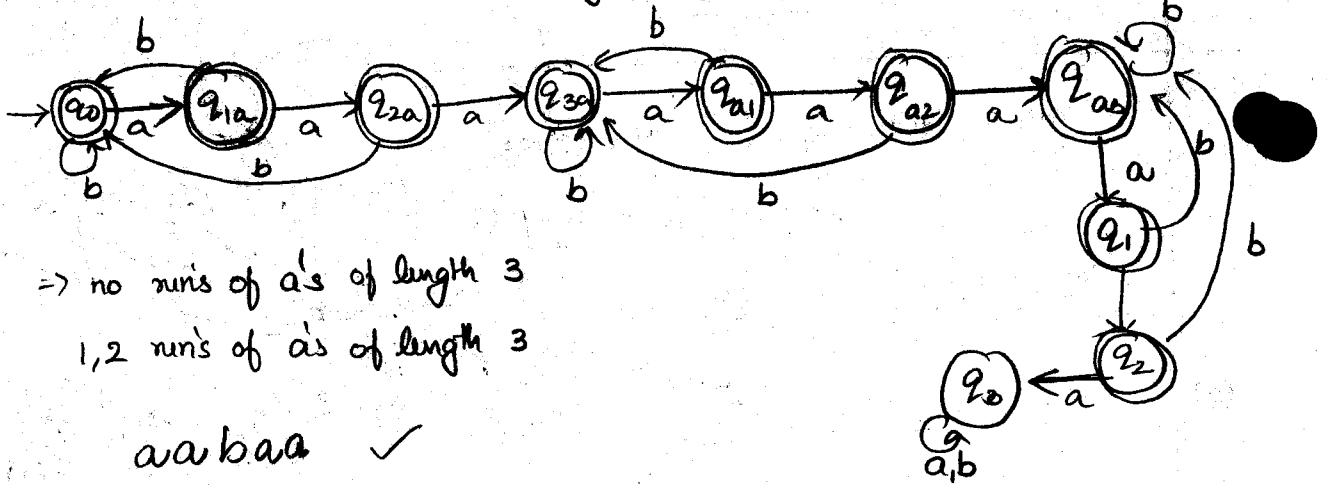

\Rightarrow no runs of a's of length 3
1, 2 runs of a's of length 3

aaabaa ✓
aaab
aaabaaa

9 $\Sigma = \{0, 1\}$

(a) Every 00 followed by 1

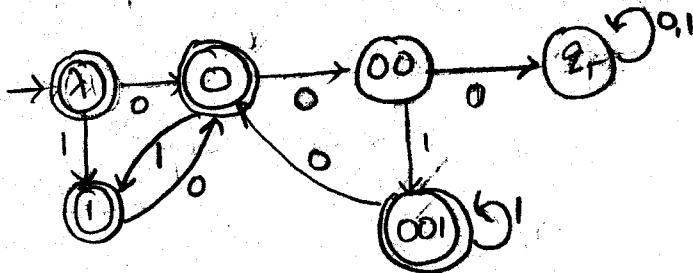

Test:

00100111 ✓
010001 X
01 ✓
10 ✓
1 ✓
0 ✓

(b) All strings containing 00 but not 000.

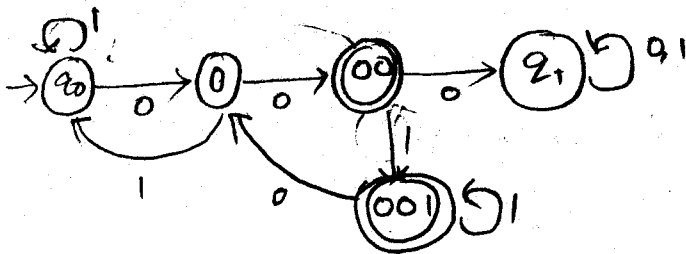

Test: 0010011 ✓

00011 ✓
1001000 X

(c) leftmost differs from rightmost.

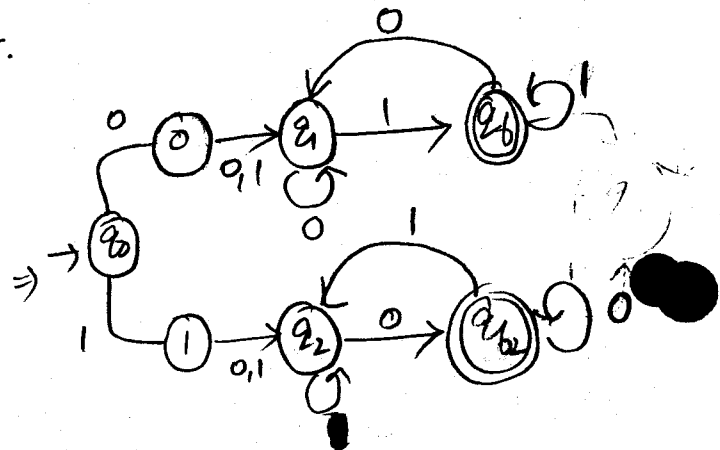
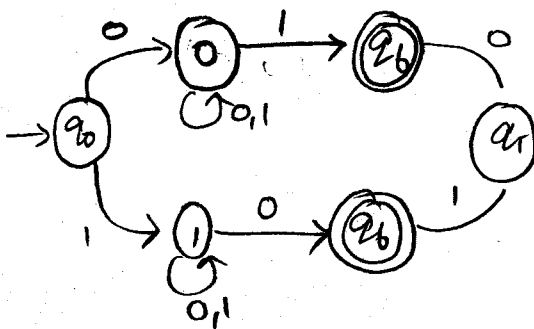

nba

lwo

Nfa:

$$M = (Q, \Sigma, \delta, q_0, F)$$

$$\delta: Q \times (\Sigma \cup \{\lambda\}) \rightarrow 2^Q$$

Example 2.7

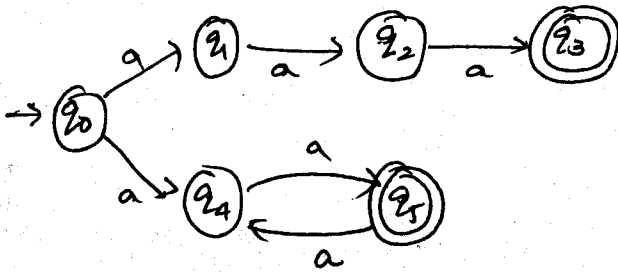

Fig 2.8

Example 2.8

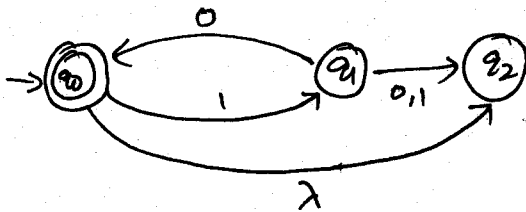

Fig 2.9

Example 2.9

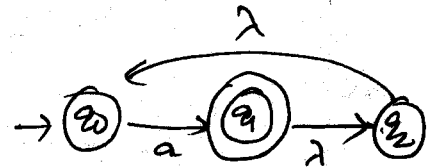

Fig 2.10

$$L(M) = \{w \in \Sigma^* : \delta^*(q_0, w) \cap F \neq \emptyset\}$$

EXERCISES

(2) find dfa defined by: fig 2.8

$$L: \{aaa\} \cup \{a^{2n} : n \geq 1\}$$

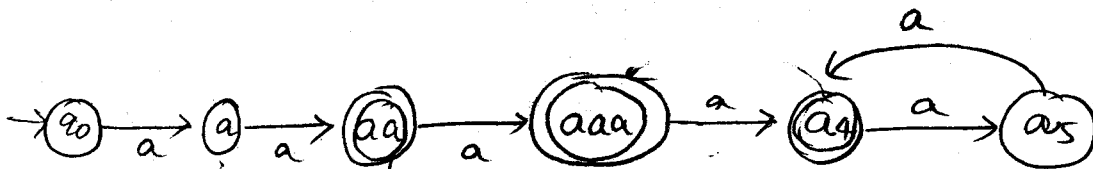

(3) find above complement.

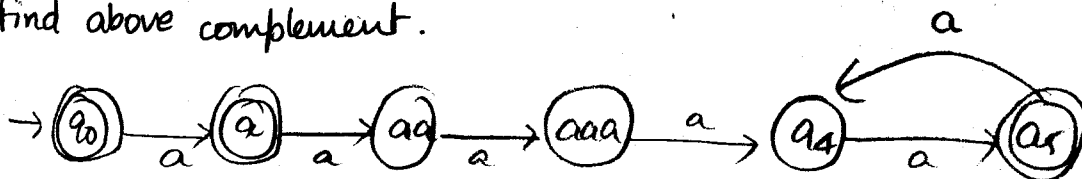

4 Fig 2.9 $\delta^*(q_0, 1011)$: $\delta^*(q_1, 011) \rightarrow \delta^*(q_0, 11) \rightarrow q_2$
 $\delta^*(q_1, 01)$ q_2

5 Fig 2.10: $\delta^*(q_0, a)$ $\{q_0, q_1, q_2\}$
 $\delta^*(q_1, \lambda)$ $\{q_0, q_2\}$

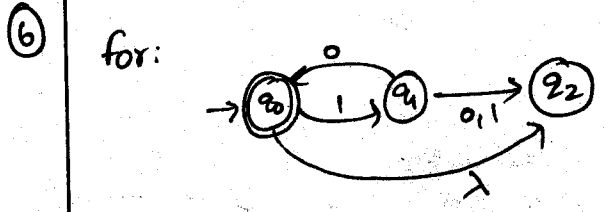

$\delta^*(q_0, 1010) \rightarrow \delta^*(q_1, 010) \rightarrow \delta^*(q_0, 10) \rightarrow \delta^*(q_1, 0) \rightarrow q_2$
 $\delta^*(q_1, 00) \rightarrow \delta^*(q_2, 1010) \rightarrow \delta^*(q_2, 10) \rightarrow \delta^*(q_2, 10) \rightarrow q_2$
 $\delta^*(q_1, 00) \rightarrow \delta^*(q_0, 0) \rightarrow q_2$
 $\delta^*(q_2, 0)$

$\{q_0, q_2\}$
 $\rightarrow q_2$

7 no more than 5 states, design nfa for
 $\{abab^n : n \geq 0\} \cup \{aba^n : n \geq 0\}$

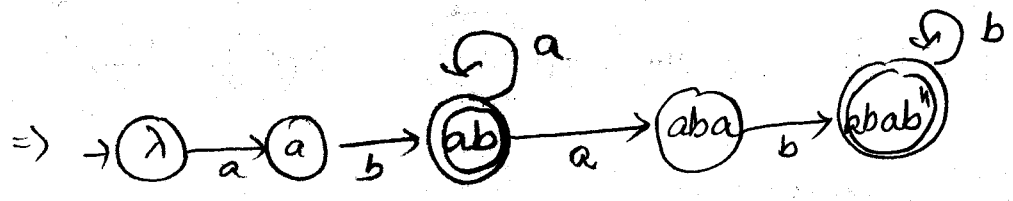
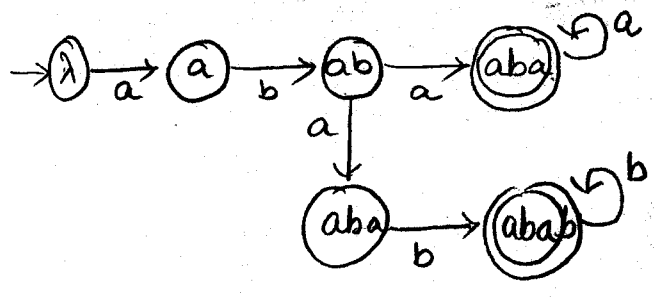

8

Construct nfa with 3 states for $\{ab, abc\}^*$

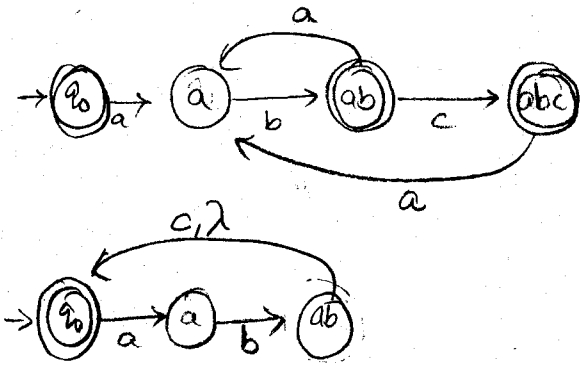

9

Can it be done in fewer states than 3?

No as $|abcb^n|_{\text{least}} = 3$ for $n=0$.

10
(a)

find nfa with 3 states that accepts

$L = \{a^n : n \geq 1\} \cup \{b^m a^k : m \geq 0, k \geq 0\}$

(b) can fewer than 3 states be possible?

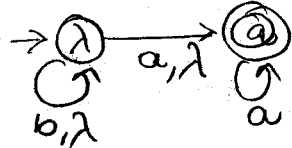
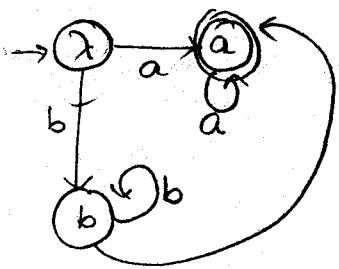

11

Nfa - 4 states for $L = \{a^n : n \geq 0\} \cup \{b^n a : n \geq 1\}$

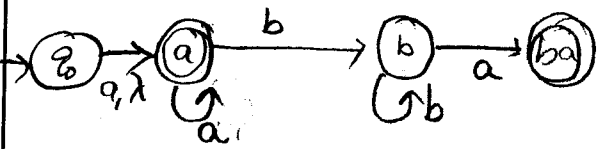

12

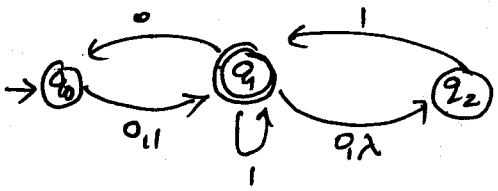

00 : $\delta^*(q_0, 00) \rightarrow \{q_0, q_2\} \cap F = \emptyset$ reject
 01001 : $\{q_1\} \cap F \neq \emptyset$ accept
 10010 : $\{q_0, q_2\} \cap F = \emptyset$ reject

000 : $\{q_1, q_2\} \cap F \neq \emptyset$ accept

0000 : $\{q_0, q_2\}$ reject

13

What is complement of

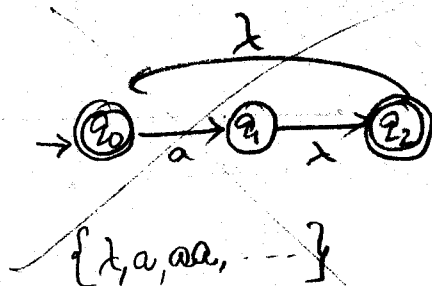
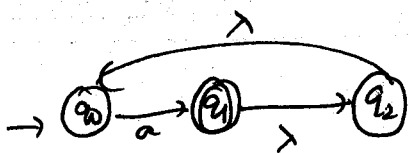

cant take complement of nfa

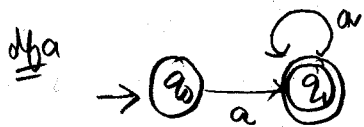

complement

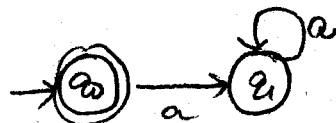

all strings $n_a(w) > 1$

all strings $n_a(w) < 1$

14

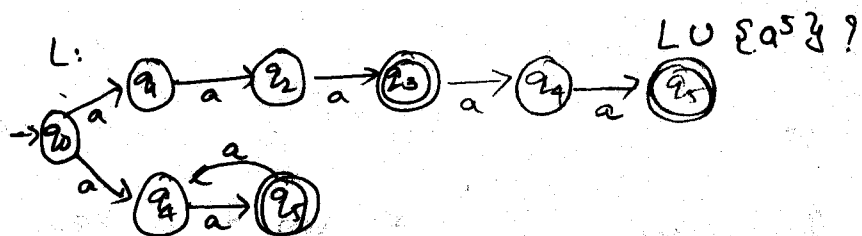

15

is? $\{a\}^* - \{a\}^+$

16

find nfa for $\{a\}^*$ such that removing one edge will accept $\{a\}$

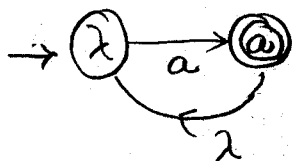

17

Can above be done with dfa?

No: need two paths to accept one a / more a's

18

let $p_0 \in Q_0$.

$\delta(p_0, \lambda) \rightarrow Q_0$

if Q_0 not initial, equivalent to M .

19

Yes.

20

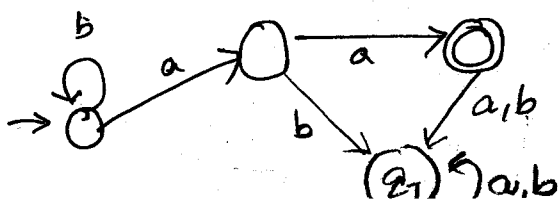

Equivalence of Nfa & Rfa:

fig 2.11

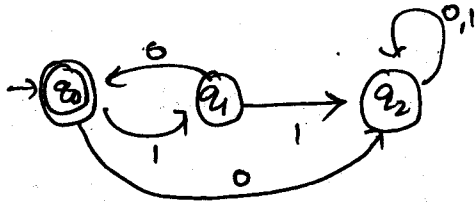

$\{\lambda, 10, 1010, \dots\}$

$\Rightarrow \{(10)^n : n \geq 0\}$

nfa

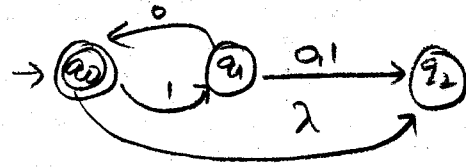

$\{(10)^n : n \geq 0\}$

fig 2.12

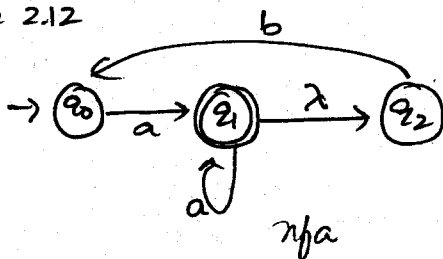

	a	b
{q0}	{q1, q2}	∅
{q1, q2}	{q1, q2}	{q0}
∅	∅	∅

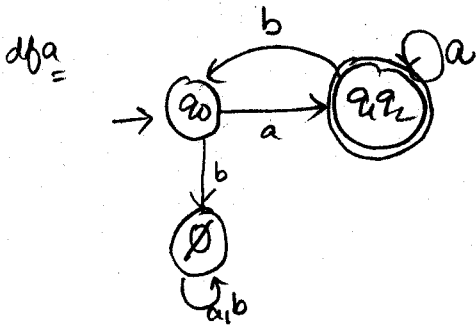

Example 2.13

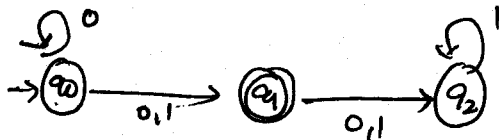

	0	1
{q0}	{q0, q1}	{q1}
{q0, q1}	{q0, q1, q2}	{q1, q2}
{q1}	{q2}	{q2}
{q2}	∅	{q2}
{q1, q2}	{q2}	{q2}

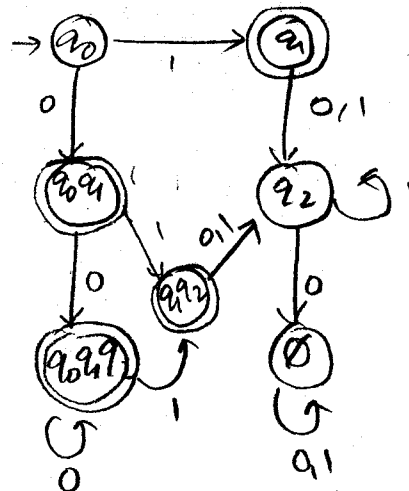

If too many states getting combined, don't end, go on & enumerate all

2-3
EXERCISES

①

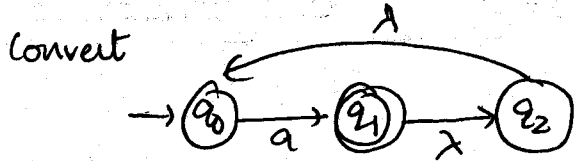

to dfa. Is there a simpler way?

Yes:
directly.

as $L = \{a^n : n > 0\}$

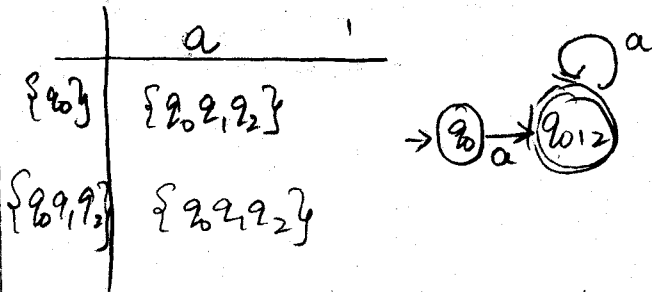
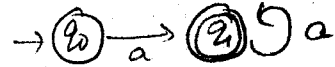

②

Convert to dfa

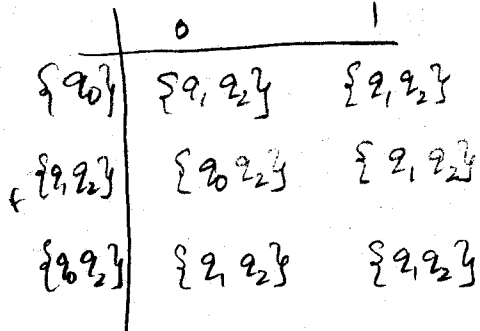
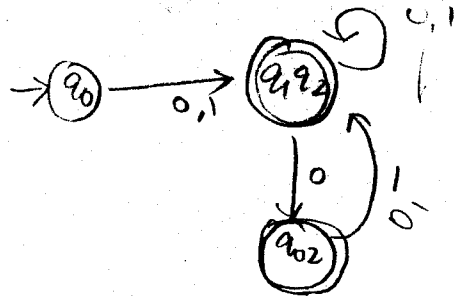
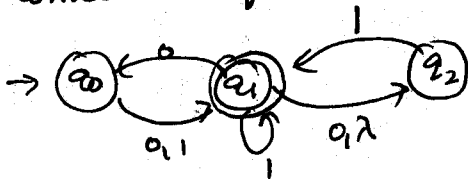

③

Convert nfa → dfa

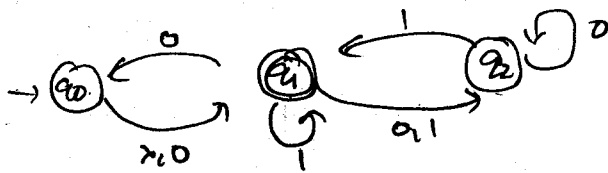

$q_0 = q_1$

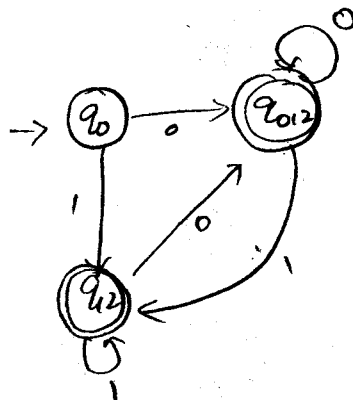
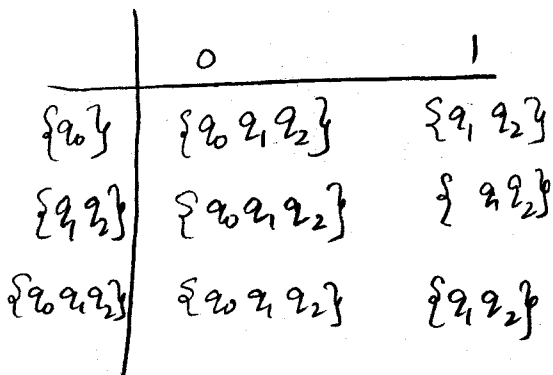

8) find nfa without λ -transitions, single final state for

$\{a\} \cup \{b^n : n \geq 1\}$

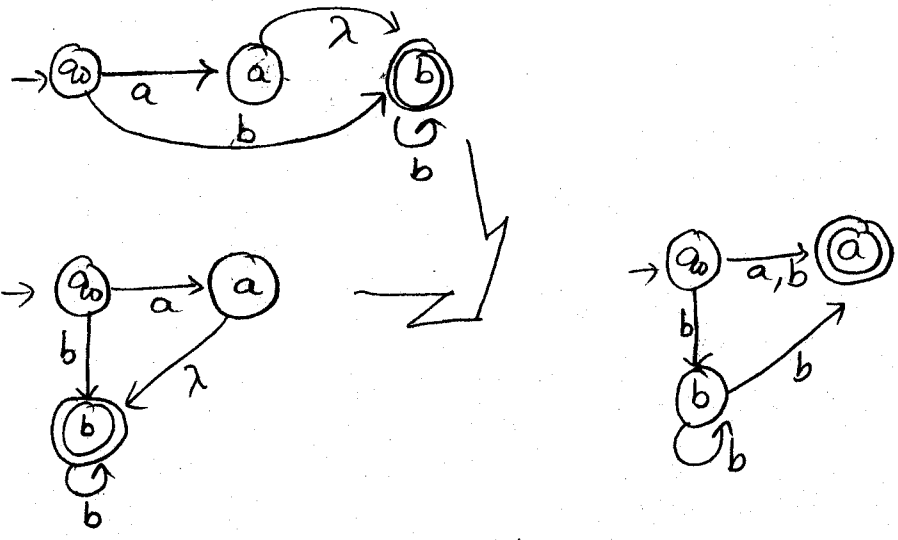

CH # 2.4

(Reduction of states in dfa)

Example 2.17

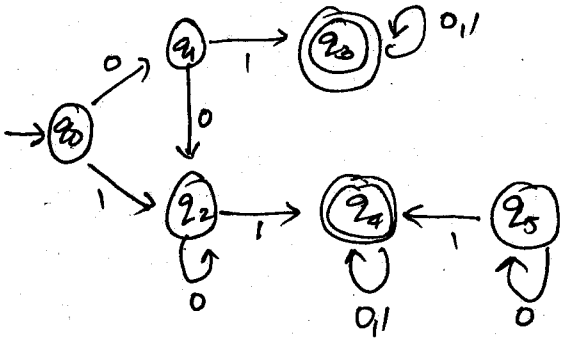

	q0	q1	q2	q3	q4
q0		D	D	D	D
q1			ID	D	D
q2				D	D
q3					ID
q4					

I states: q3

D: {q0, q1}, {q0, q2}

ID: {q3, q4}, {q1, q2}

{q0}, {q1, q2}, {q3, q4}

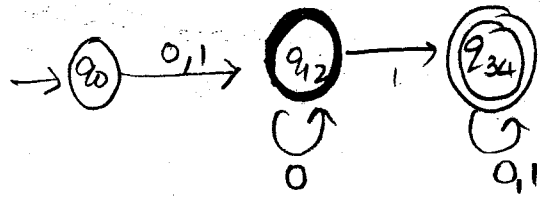
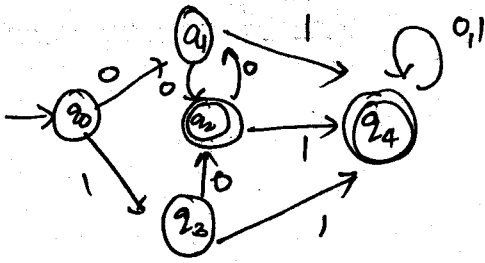

fig: 2.18



D: $\{q_1, q_4\}$
 $\{q_2, q_4\}$
 $\{q_3, q_4\}$
 $\{q_0, q_4\}$

ID: $\{q_1, q_3\}$
 \downarrow \downarrow
 $\{q_2\}$ $\{q_4\}$

	q_0	q_1	q_2	q_3	q_4
q_0		D	D	D	D
q_1			ID	ID	D
q_2				ID	D
q_3					D
q_4					

~~$\{q_0\}, \{q_1, q_2, q_3\}, \{q_4\}$~~

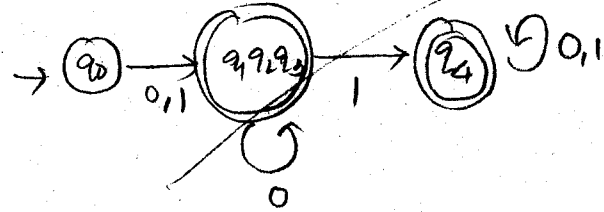

EXERCISES

② ca) find minimal dfa for

$L = \{a^n b^m : n \geq 2, m \geq 1\}$

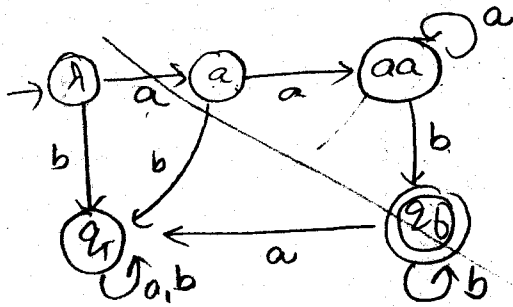

ID: (aa, q_2)
 (λ, q_1)

D: (a, q_2) (λ, q_2) (q_1, aa)
 (q_1, q_2) (λ, aa) (q_1, aa)

	λ	a	aa	q_1	q_2
λ		D	D	D	ID
a			D	D	D
aa				ID	D
q_1					D
q_2					

~~$\{\lambda, q_1\}, \{a\}, \{aa\}, \{q_1\}, \{q_2\}$~~

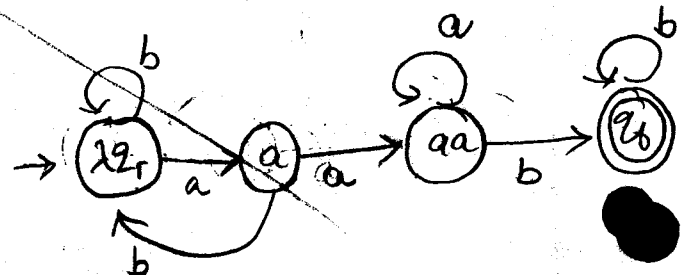

(a) $L = \{ a^n b^m : n \geq 2, m \geq 1 \}$

minimal

(b) $L = \{ a^n b : n \geq 0 \} \cup \{ b^n a : n \geq 1 \}$

(c) $L = \{ a^n : n \geq 0, n \neq 3 \}$

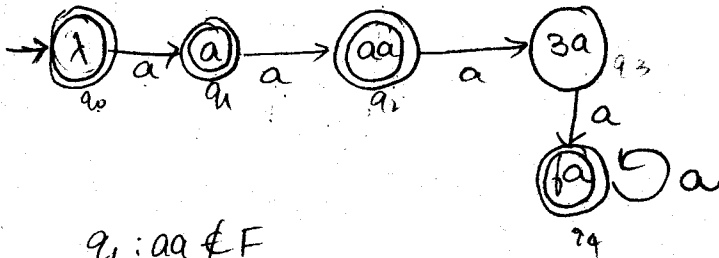

$q_1 : aa \notin F$
 $(q_4, aa) \in F \quad \therefore (q_1, q_4) D$

$(\lambda, aaa) \notin F \quad \therefore (\lambda, q_3),$
 $(q_3, aaa) \in F \quad D$

	λ	a	aa	3a	fa
λ	D	D	D	D	
a		D	D	D	
aa			D	D	
3a				D	
fa					

already in minimal //

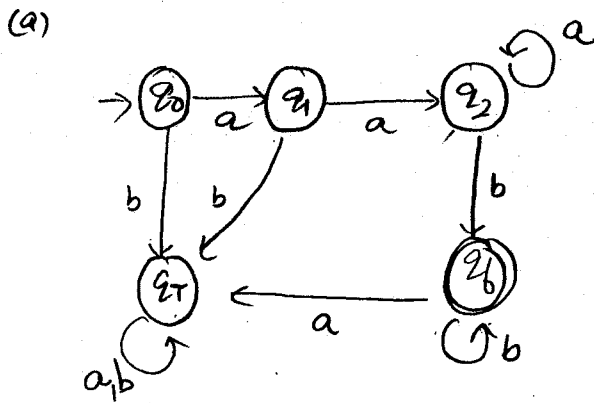

$q_4 \in F$
 rest $\notin F \quad \therefore D\text{-states}$

	q_0	q_1	q_2	q_3	q_4
q_0	D	D	D	D	
q_1		D	D	D	
q_2			D	D	
q_3				D	
q_4					

\therefore minimal

CHAPTER : 3

RL \neq RQ

$$\rightarrow L(r_1 + r_2) = L(r_1) \cup L(r_2)$$

$$L(r_1 r_2) = L(r_1) \cdot L(r_2)$$

$$L(r_1^*) = (L(r_1))^*$$

Example
3.2

$$L(a^* \cdot (a+b)) ?$$

$$\begin{aligned} L(a^* \cdot (a+b)) &= L(a^*) \cdot L(a+b) \\ &= L(a^*) \cdot \{L(a) \cup L(b)\} \\ &= L(a^*) \cdot \{a, b\} \\ &= \{\lambda, a, aa, \dots\} \cdot \{a, b\} \\ &= \{a\}^+ \cup \{a^n b^{m+1} : n \geq 0\} \end{aligned}$$

Example
3.3

$$\Sigma = \{a, b\}$$

$$r = (a+b)^* \cdot (a+bb)$$

$$\{a, b\}^* \cdot \{a, bb\} = \{a, bb, aa, abb, ba, bbb, \dots\}$$

Example
3.4

$$r = (aa)^* (bb)^* b$$

$$L = \{(aa)^n (bb)^m b : n \geq 0\}$$

$$L = \{a^{2n} b^{2m+1} : n, m \geq 0\}$$

Example
3.5
$$\Sigma = \{0, 1\} : \omega \text{ has at least one pair of consecutive zeroes.}$$

$$(0+1)^* 00 (0+1)^*$$

$$(1+01)^* (0+\lambda)$$

3.6

no consecutive zeroes:

EXERCISES

①

$L \{ (a+b)^* b (a+ab)^* \}$ find strings $|w| < 4$.

$\{ \lambda, a, b, ab, ba, aa, bb, aba, baa, aaa, bba, bab, abb, aab, \dots \} \cdot b$
 $\{ \lambda, a, ab, aab, aba, aaa \} \dots$

$|w| < 4$: $\{ b, ab, bb, ba, bab \dots \}$

②

$((0+1)(0+1)^*)^* 00 (0+1)^*$ denote @least one pair of consecutive 0's.
 yes.

③

$r = (1+01)^* (0+1)^*$ also denotes no consecutive zeroes.

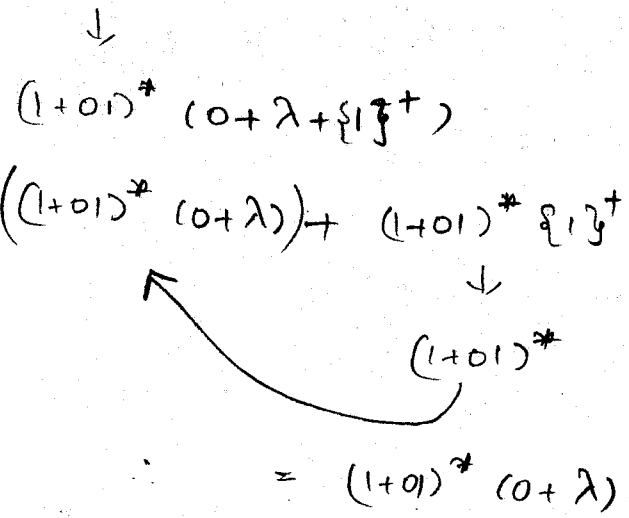

④

RE? $\{ a^n b^m : n \geq 3, m \text{ is even} \}$

$$aaa(a^*)(bb)^*$$

⑤

RE=? $\{ a^n b^m : (n+m) \text{ is even} \}$

$$\underline{\underline{\{ (aa)^*(bb)^* + (aa)^* a (bb)^* b \}}}$$

RE = ?

⑥

(a)

$$L_1 = \{a^n b^m : n \geq 4, m \leq 3\}$$

$$aaaa \cdot a^* (\lambda + b + bb + bbb)$$

(b) $L_2 = \{a^n b^m : n < 4, m \leq 3\}$

$$(\lambda + a + aa + aaa) (\lambda + b + bb + bbb)$$

(c) $\bar{L}_1 : \{a^n b^m : n < 4, m > 3\}$ (d)

X $(\lambda + a + aa + aaa) bbbb b^* +$

either $n < 4$ or $m \geq 4$ (or) $a^k b^k$

$$(\lambda + a + aa + aaa) b^* + a^* bbbbb^* +$$

$$(a+b)^* b a (a+b)^*$$

(d) $\bar{L}_2 : \{a^n b^m : n < 4, m \leq 3\}$

$$n \geq 4 / m > 3$$

$$\bar{L}_2 : aaaaa^* b^* + a^* bbbb b^* + (a+b)^* b a (a+b)^*$$

⑦

$$L [(aa)^* b (aa)^* + a(aa)^* b a(aa)^*]$$

$$wbw : w : a^{2n} : n \geq 0$$

$$w : a^{2n+1} : n \geq 0$$

b having even a's on both ends or
b having odd a's on both ends.

RE(L) =
all possible
rule
breakers
in
RE(L)

→

(16)

(a) $\Sigma = \{a, b, c\}$

Exactly one a.

$$(b+c)^* a (b+c)^*$$

a ✓ bcbea ✓
ab ✓ bcaax ✗

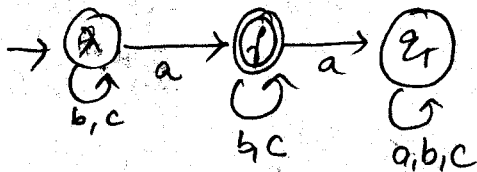

(b) no more than 3 a's.

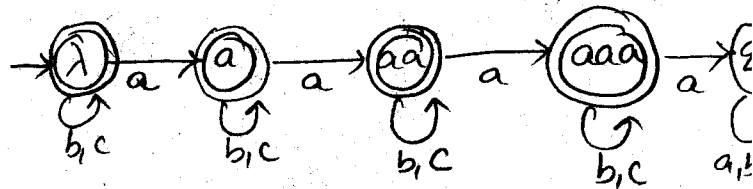

$$\left[(b+c)^* a (b+c)^* a (b+c)^* a (b+c)^* + (b+c)^* + (b+c)^* a (b+c)^* + (b+c)^* a (b+c)^* a (b+c)^* \right]$$

Test: aa ✓ aaaa ✗
bca ✓

(c) @least one occurrence of each symbol in Σ

$$(a+b+c)^* a (a+b+c)^* b (a+b+c)^* c (a+b+c)^*$$

(d) no run of a's $|w|_a > 2$

0, 1, 2

$$(\lambda + a + aa + b + c)^*$$

~~$$(b+c)^* (\lambda + a) (b+c)^* (\lambda + a) (b+c)^*$$~~

(e) run's of a's are multiples of 3.

~~$$(b+c)^* aaaa^* (b+c)^* aaaa^* (b+c)^*$$~~

$$(\lambda + aaaa^* + b + c)^*$$

(17) (a) Ending in 01

$$(0+1)^* 01$$

(b) Even no. of zeroes

$$[1^* 0^* 0^* + 1]^*$$

(17) (b) Not Ending in 01:

$$1^* (0+01+11)^* 11^* (0+\lambda)$$

sample 3-11

RE = ?

$L = \{ w \in \{a,b\}^+ : n_a(w) \text{ is even, } n_b(w) \text{ is odd} \}$

FIND RE for a DFA?

\emptyset to all unknown moves!

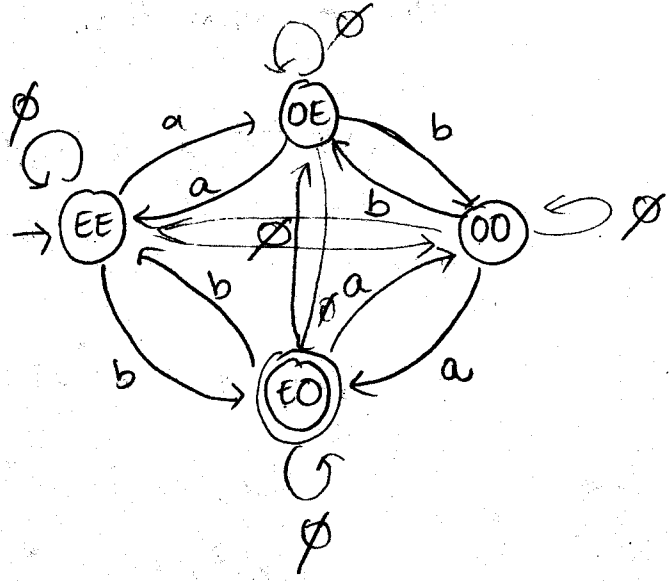

$r + \emptyset = r$
 $r \emptyset = \emptyset$
 $\emptyset^* = \lambda$

step 1

$r_{EE} = \emptyset + a \emptyset^* a$
 $= aa$

step 2 now 3-state Rule

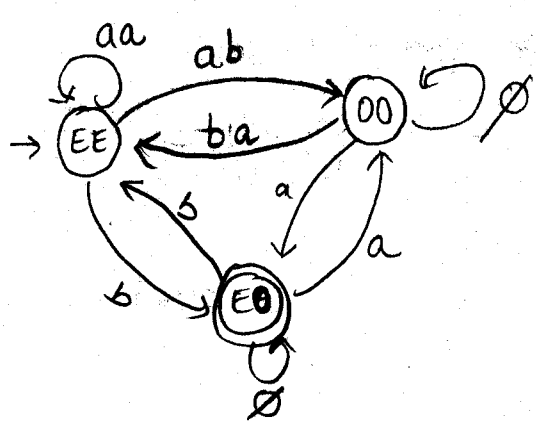

EXERCISE

$L(ab^+aa + bba^+ab)$:

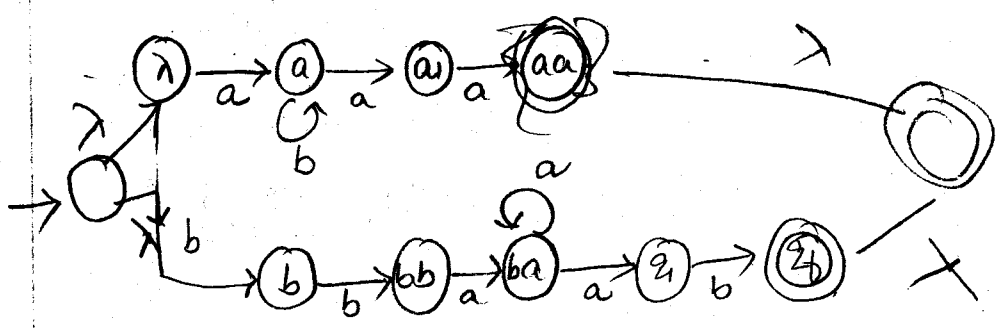

3

nfa? $((a+b)^* b (a+bb)^*)$

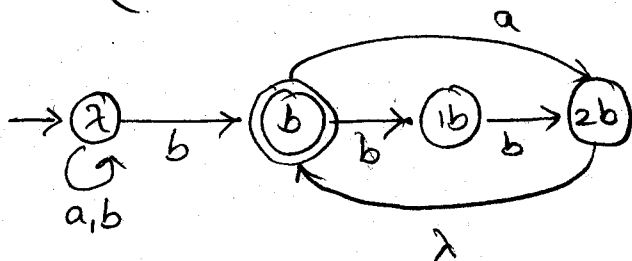

4

a) dfa?

$L(aa^* + aba^*b^*)$

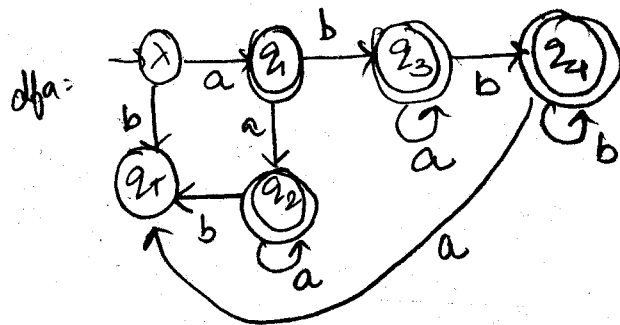
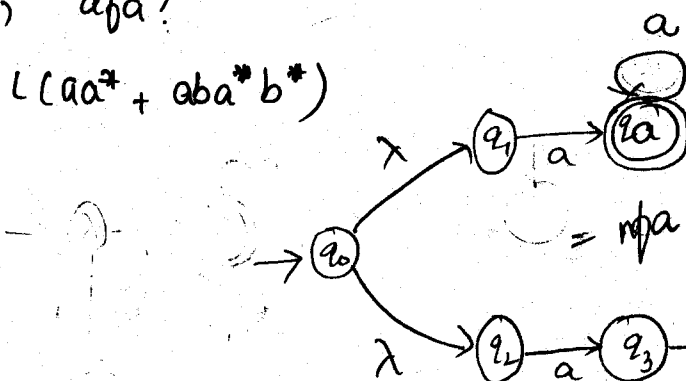

Removing an edge in a transition graph $(q_0 \notin F)$

8

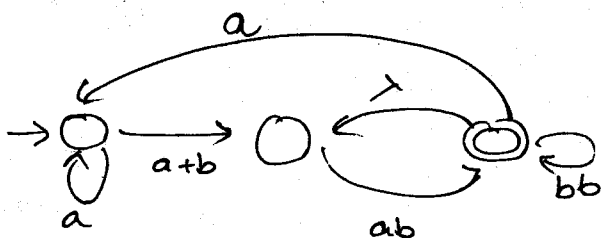

$$r = a^* (a+b) ab (ab + bb + aa^* (a+b) ab)^*$$

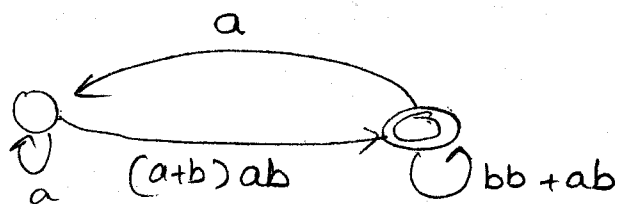

$$aabb bbb$$

10

(b)

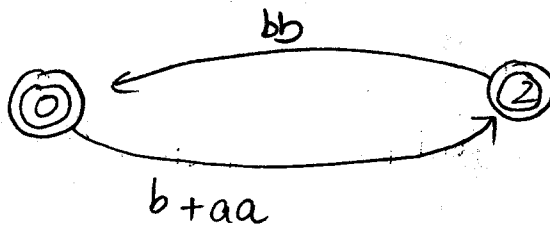
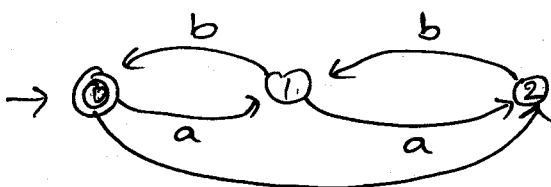

$q_0 \notin F$

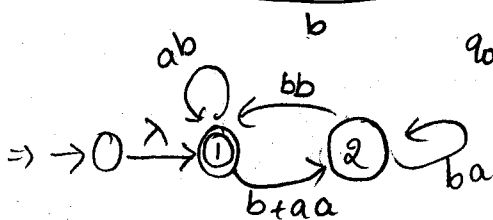

$$ab + (b+aa)(ba)^* bb$$

(13)

EE=? on $\Sigma = \{a, b\}$
 (a) $L = \{w : n_a(w), n_b(w) \text{ are even}\}$

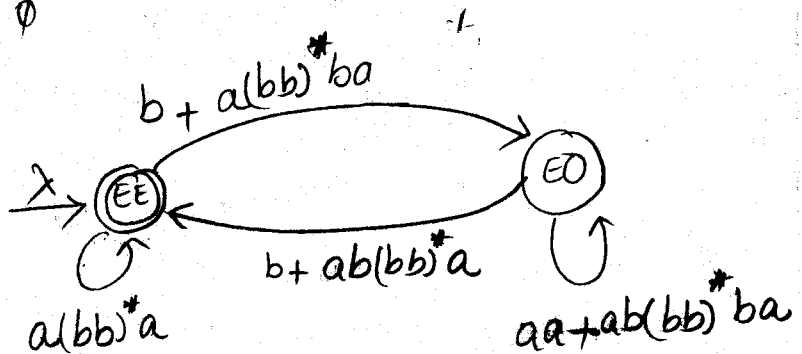
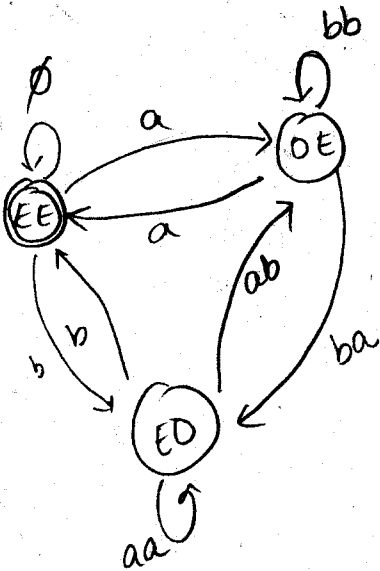
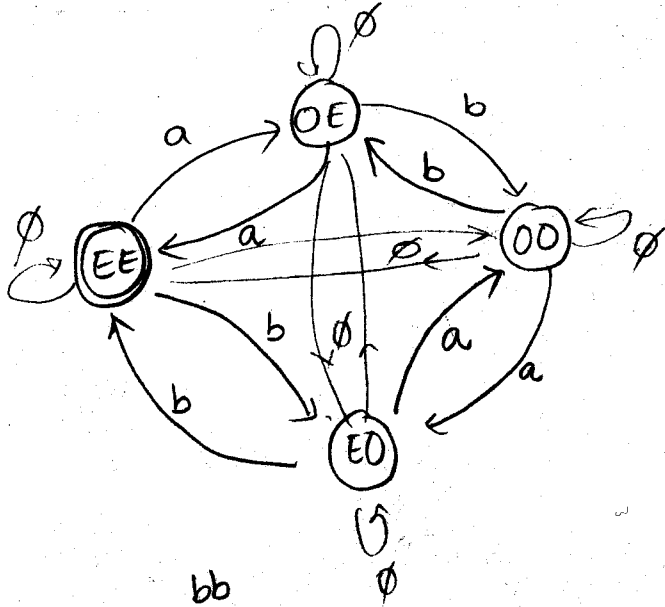

RE:

$$\lambda + [a(bb)^*a][b + a(bb)^*ba][aa + ab(bb)^*ba][b + ab(bb)^*a]^*$$

$\lambda \checkmark$
 $aa \checkmark$

CH # 3.3

(1)

dfa=?

$S \rightarrow abA$
 $A \rightarrow baB$
 $B \rightarrow aA/bb$

$$abbaa[(ab)^* + bb]$$

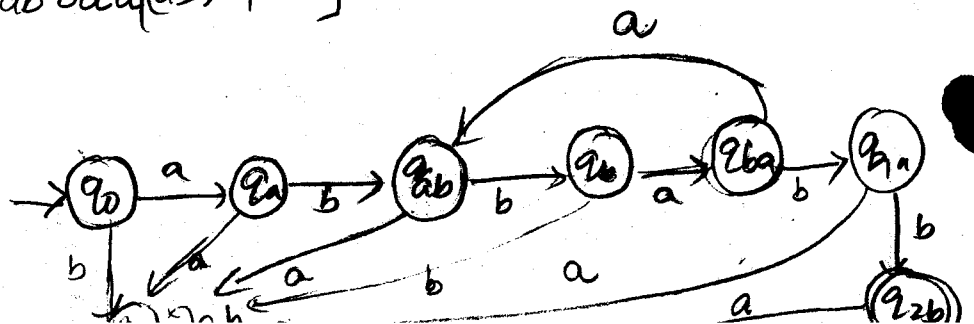

3

LG = ? for 1

$S \rightarrow abA$

$A \rightarrow baB$

$B \rightarrow aA / bb$

RE =

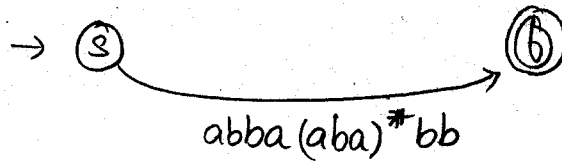
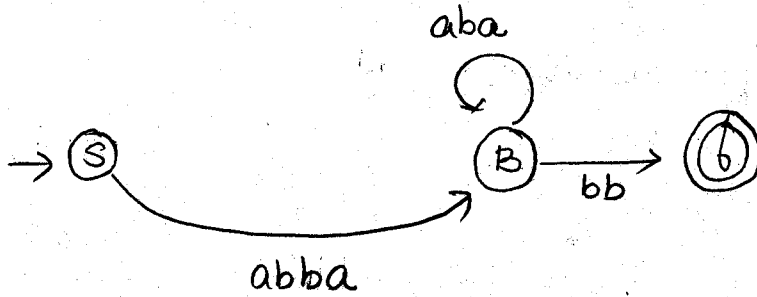
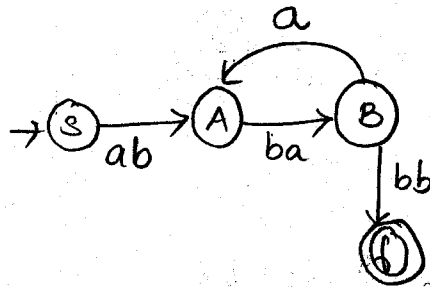

Test: abbabb ✓

abbaabaababb ✓

$S \rightarrow ABbb$

$A \rightarrow abba$

$B \rightarrow Baba / \lambda$

$S \rightarrow ABbb \rightarrow abbaBbb \rightarrow$

$abbaBaba bb \rightarrow$

$abba(aba)^* bb \checkmark$

4

RLG, LLG = ?

$\{a^n b^m : n \geq 2, m \geq 3\}$

RLG:

$S \rightarrow aaAB$

$A \rightarrow aA / \lambda$

$B \rightarrow bbbC$

$C \rightarrow bC / \lambda$

LLG

$S \rightarrow aaA bbbB$

$A \rightarrow aA / \lambda$

$B \rightarrow bB / \lambda$

LLG:

$S \rightarrow ABbbb$

$A \rightarrow Caa$

$C \rightarrow Ca / \lambda$

$B \rightarrow Bb / \lambda$

RLG=?

$(aab^*ab)^*$

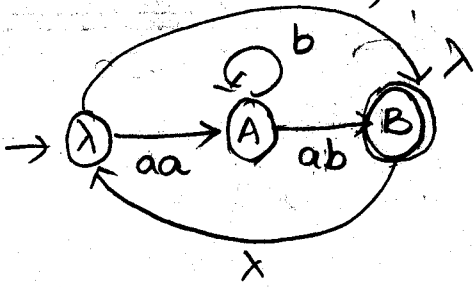

$S \rightarrow aaA / \lambda$

$A \rightarrow bA / abS$

13

(a) ~~REG~~ RG=?

$\Sigma = \{a, b\}$

(a) $n_a(w), n_b(w)$ are even.

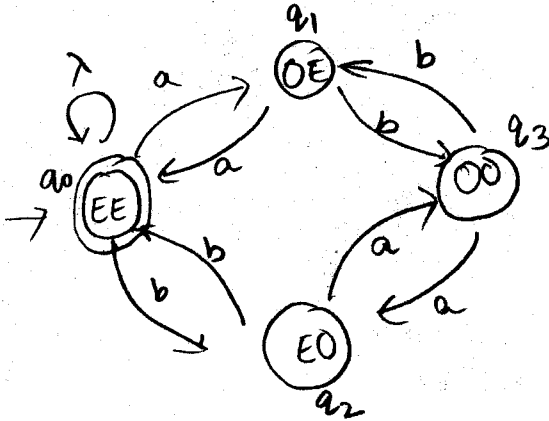

$q_0 \rightarrow aq_1 / \lambda / bq_2$

$q_1 \rightarrow bq_3 / aq_0$

$q_2 \rightarrow aq_3 / bq_0$

$q_3 \rightarrow aq_2 / bq_1$

$$(n_a - n_b) \bmod 3 = 1$$

draw

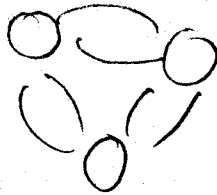

Right Quotient: L_1/L_2

$L_1: \{a^m b^n : m \geq 1, n \geq 0\} \cup \{ba\}$

$L_2: \{b^m : m \geq 1\}$

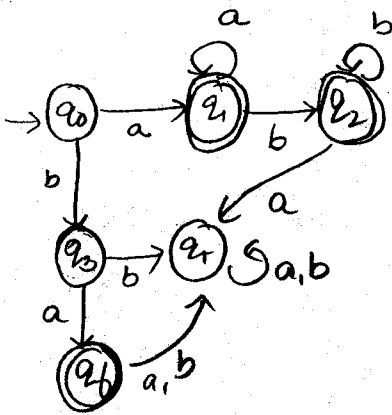

for L_1/L_2

final states are:

q_1, q_2

RIGHT QUOTIENT
 L_1/L_2
~~draw dfa~~
 for L_1
 \rightarrow 4 nodes
 apply L_2
 to check final state

Exercises

②

(a) $(a+b)a^* \cap (baa^*)$

$nba = ?$

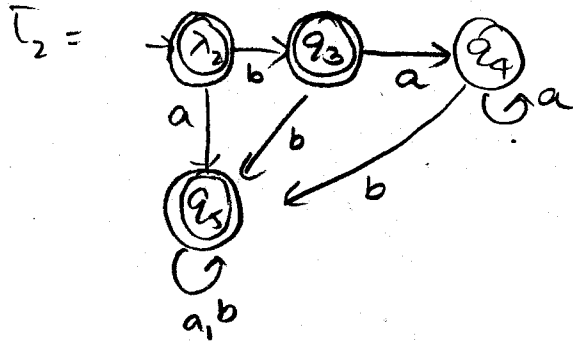
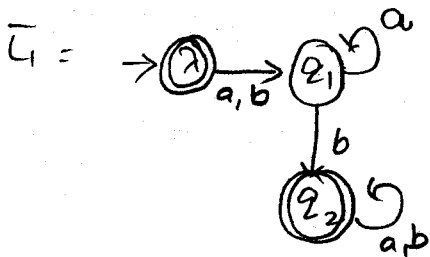
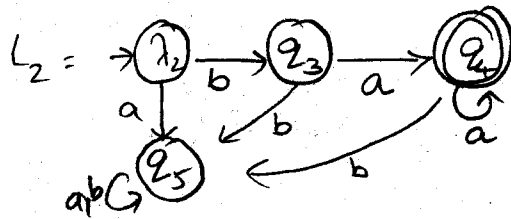
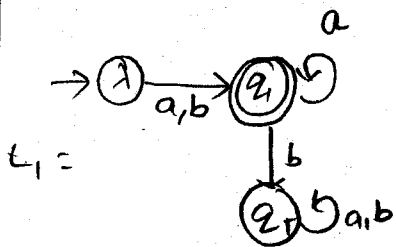

④ (b) $ab(ab)^*(a+aa)$

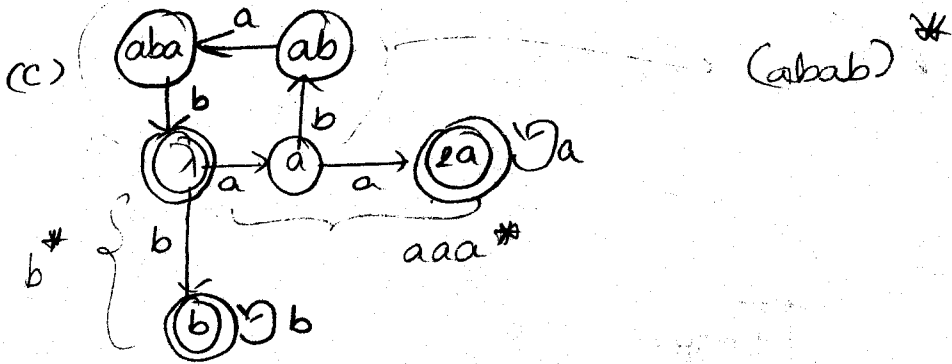
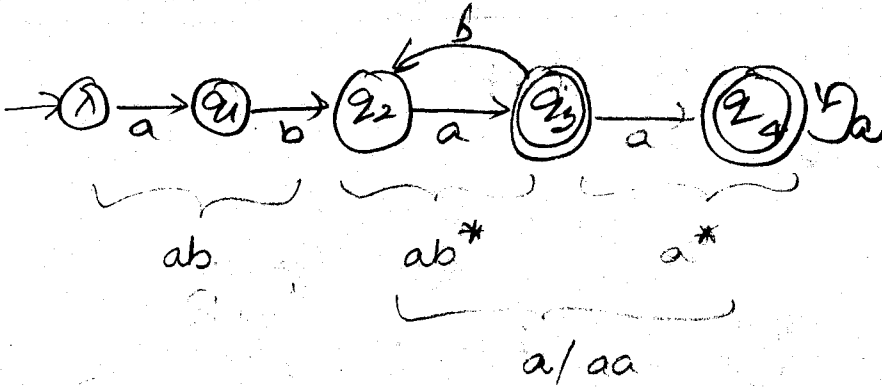

(d)

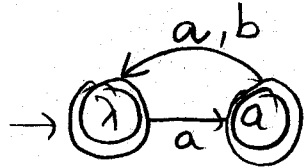

$\lambda, a, aa, ab, abab$
 (aa^*b)

(b)

⑤ (a)

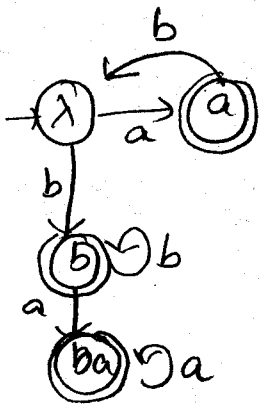

ab^*a^*
 $a \checkmark$
 $aba \checkmark$
 $abba \checkmark$
 ab^*a
 abb

⑦

$bb \checkmark$
 $abb \checkmark$
 a^*bb
 ab^*ba
 $aba \checkmark$
 $abba \checkmark$
 $abbb \checkmark$
 a^*bba

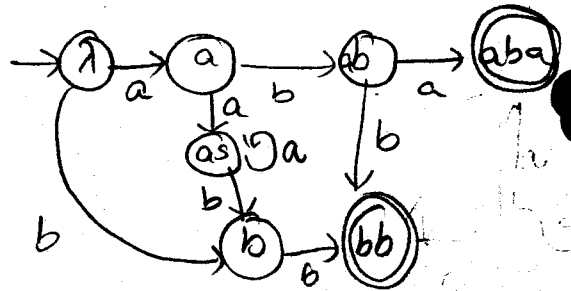

CONTEXT-FREE GRAMMARS

A Grammar $G = (V, T, S, P)$ is CF if all productions in P are of the form

$$A \rightarrow x$$

$$(x \in (V \cup T)^*, A \in V)$$

Example 5.1

$$G = (\{S\}, \{a, b\}, S, P)$$

- P:
- $S \rightarrow aSa$
 - $S \rightarrow bSb$
 - $S \rightarrow \lambda$

$$S \rightarrow aSa \rightarrow abba$$

$$S \rightarrow aSa \rightarrow aaaSaa \rightarrow aabbbaa$$

$$L(G) = \{ww^R : w \in \Sigma^*\}$$

Example 5.2

G: P:

- $S \rightarrow abB$
- $A \rightarrow aaBb$
- $B \rightarrow bbAa$
- $A \rightarrow \lambda$

$$S \rightarrow abbbAa \rightarrow \boxed{abbbA} (ba)^0$$

$$\rightarrow abbbAaBba \rightarrow \boxed{abbbA} \boxed{bbba}$$

$$\rightarrow abbbAaBbaBbaba \rightarrow \boxed{abbbA} \boxed{bbba} \boxed{bbba} \boxed{bbba}$$

$$\rightarrow abbbAaBbaAababa \rightarrow \boxed{abbbA} \boxed{bbba} \boxed{bbba} \boxed{bbba}$$

$$L(G) = \{ab(bbba)^n bba(ba)^m : n, m \geq 0\}$$

Example 5.3

ST $L = \{a^n b^m : n \neq m\}$ is context free.

$$\left(\begin{array}{l} L: \{a^n b^m : n \geq 0\} \\ S \rightarrow aSb / \lambda \end{array} \right)$$

- $S \rightarrow aSb / aA / bB$
- $A \rightarrow aA / \lambda$
- $B \rightarrow bB / \lambda$

- $S \rightarrow AS_1 / BS_1$
- $A \rightarrow aA / \lambda$
- $B \rightarrow bB / \lambda$
- $S_1 \rightarrow aS_1b / \lambda$

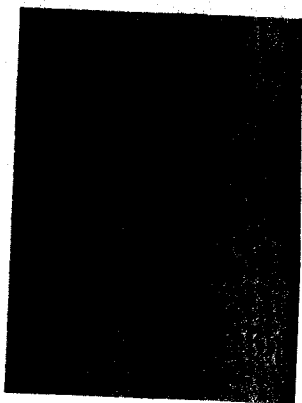

Example 5.4

$$S \rightarrow asb / SS / \lambda$$

$$L(G) = \{ w : w \in \{a,b\}^* , n_a(w) = n_b(w) \text{ \& } n_a(\gamma) \geq n_b(\gamma) , \gamma \text{ is any prefix of } w \}$$

$S \rightarrow asb \rightarrow aaSbb \rightarrow aabb$
 $S \rightarrow SS \rightarrow asbaSb \rightarrow abab \dots$

Leftmost & Right Most derivations:

$S \rightarrow AB$	$S \rightarrow aaABb$
$A \rightarrow aaA$	$A \rightarrow aaA / \lambda$
$A \rightarrow \lambda$	$B \rightarrow Bb / \lambda$
$B \rightarrow Bb / \lambda$	

$$L(G) = \{ a^{2n} b^m : n, m \geq 0 \}$$

Example 5.5

$S \rightarrow aAB$	$S \rightarrow aAB \rightarrow abBb \rightarrow \text{abb}$
$A \rightarrow bBb$	$S \rightarrow aAB \rightarrow abBbbBb \rightarrow \text{abbbb}$
$B \rightarrow A / \lambda$	$S \rightarrow aAB \rightarrow abBbbBb \rightarrow abbbBbb \rightarrow \text{abbbbb}$

$$L(G) = \{ ab^{2^n} : n > 0 \}$$

Example 5.6

$S \rightarrow aAB$
 $A \rightarrow bBb$
 $B \rightarrow A / \lambda$

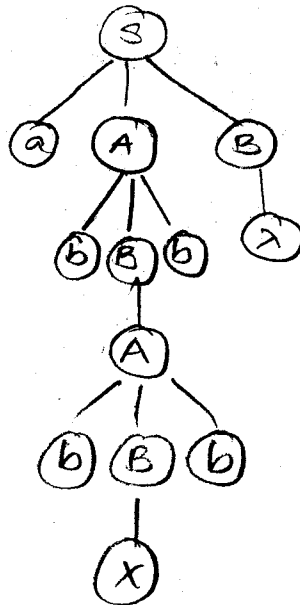

CHAPTER : 5-1
(CONTEXT FREE GRAMMARS)

Def: $G = (V, T, S, P)$
 $A \rightarrow \alpha$
 $\alpha \in (V \cup T)^*$

Eg: 5.1

$G = (\{S\}, \{a, b\}, S, P)$

$S \rightarrow aSa$
 $S \rightarrow bSb$
 $S \rightarrow \lambda$

$L(G) = \{w w^R : w \in \{a, b\}^*\}$

G is CFG, but not regular.

Eg: 5.2

$S \rightarrow abB$
 $A \rightarrow aAb$
 $B \rightarrow bBa$
 $A \rightarrow \lambda$

$S \Rightarrow abbbAa \Rightarrow \underline{abbb} \underline{a}$
 $\Rightarrow \underline{abbb} \underline{a} \underline{bb} \underline{ba}$
 $\Rightarrow \underline{abbb} \underline{a} \underline{abb} \underline{A} \underline{aba} \Rightarrow \underline{abbb} \underline{a} \underline{abb} \underline{a} \underline{a} \underline{bb} \underline{ab} \underline{aba}$

$L(G) = \{ab (bbaa)^n bba (ba)^n : n \geq 0\}$

Eg: 5.3

$L = \{a^n b^m : n \neq m\}$

$\left(\begin{array}{c} n=m \\ S \rightarrow aSb / \lambda \end{array} \right)$

$n > m$

$a^{n+x} b^n$

$S_1 \rightarrow AB$
 $A \rightarrow aA / a$
 $B \rightarrow aBb / \lambda$

$n < m, m \geq n$

$a^n b^{n+x}$

$S_2 \rightarrow BC$
 $C \rightarrow Cb / b$

\therefore

$S \rightarrow AB / BC$
 $B \rightarrow aBb / \lambda$
 $A \rightarrow aA / a$
 $C \rightarrow bC / b$

$G = (V, T, S, P)$

Ex. 5.4

$$S \rightarrow aSb \mid SS \mid \lambda$$

$$\Rightarrow L(a) = \{ w \in \Sigma_{a,b}^* : n_a(w) = n_b(w), n_a(\gamma) \geq n_b(\gamma) \text{ where } \gamma \text{ is prefix of } w \}$$

$$\begin{aligned} S &\rightarrow AB \\ A &\rightarrow aA \mid \lambda \\ B &\rightarrow Bb \mid \lambda \end{aligned}$$

$$L = \{ a^{2n} b^m : m, n \geq 0 \}$$

(EXERCISES)

②

$$\begin{aligned} S &\rightarrow aSa \\ S &\rightarrow bSb \\ S &\rightarrow \lambda \end{aligned}$$

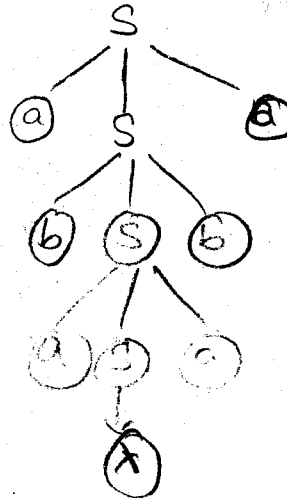

⑦

Find CFG for $n \geq 0, m \geq 0$

⑧

$$L = \{ a^n b^m : n \leq m+3 \}$$

$$\left. \begin{aligned} n=m \\ S &\rightarrow aSb \mid \lambda \end{aligned} \right\}$$

- ① $n = m+3 \rightarrow$
- ② $n < m+3 \Rightarrow$ add any no. of b's

↓

$$\begin{aligned} S &\rightarrow aaaS \\ A &\rightarrow aAb \mid B \\ B &\rightarrow bB \mid \lambda \end{aligned}$$

$$n \leq m+3 \Rightarrow n=0,1,2$$

$$\begin{aligned} S &\rightarrow aA \mid aaaS \mid aaaS \\ A &\rightarrow aAb \mid B \\ B &\rightarrow bB \mid \lambda \end{aligned}$$

$$\begin{aligned} n=m+3 \\ a^n b^m &\Rightarrow a^{m+3} b^m \end{aligned}$$

$$\begin{aligned} S &\rightarrow AB \\ A &\rightarrow aaaS \\ B &\rightarrow aBb \mid \lambda \end{aligned}$$

$$S \rightarrow aSb \mid aaaS$$

$$\begin{aligned} S &\rightarrow aaaS \\ A &\rightarrow aAb \mid \lambda \end{aligned}$$

$$m=0 : n=0 \quad n=1 \quad n=2 \quad n=3$$

λ ✓ a ✓ aa ✓ aaaS ✓

$$m=1 : n=1 \quad n=2 \quad n=3 \quad n=4$$

ab ✓ aab ✓ aaaS ✓ aaaS ✓

$$\begin{aligned} m=1 \quad n=5 \quad \times \\ aaaSab \\ aaaS \rightarrow aaaS \end{aligned}$$

CH: 5.1
EXERCISES.

7 (b)

HW

$$L = \{ a^n b^m : n \neq m-1 \}$$

- $n=0, m=1 : b \checkmark$
- $n=1, m=2 : abb \checkmark$
- $n=1, m=1 : ab \times$

$$\begin{aligned} n &= m-1 \\ m &= n+1 \end{aligned} \quad \begin{aligned} S &\rightarrow Ab \\ A &\rightarrow aAb/\lambda \end{aligned}$$

$n < m-1$

add b's

$$\begin{aligned} S &\rightarrow Ab \\ A &\rightarrow aAb/B \\ B &\rightarrow bB/b \end{aligned}$$

$n > m-1$

add a's

$$\begin{aligned} S &\rightarrow Ab \\ A &\rightarrow aAb/C \\ C &\rightarrow aC/a \end{aligned}$$

Test: $n: 0, 1, 2 : m=4$

- \checkmark $bbbb : S \rightarrow Ab \rightarrow Bb \rightarrow bbbb \checkmark$
- \checkmark $abbbb : S \rightarrow Ab \rightarrow aAbb \rightarrow aBbb \rightarrow abbbb \checkmark$
- \checkmark $aaabbbb : S \rightarrow Ab \rightarrow aaAbbb \rightarrow aabbbb \checkmark$
- \checkmark $aaaabbbb : S \rightarrow Ab \rightarrow aaaAbbbb \rightarrow aaabbbb \times$
- \checkmark $aaaaabbbb : S \rightarrow aaaaAbbbb \times$

Test $m=3, n: 3, 4, 5, 6 \dots$

- \checkmark $aaabbb : S \rightarrow aaAbbb \rightarrow aaabbb \checkmark$
- \checkmark $aaaabbb : aaAbbb \rightarrow aaaCbb \rightarrow aaaabbb \checkmark$

$\therefore n \neq m-1$

\Rightarrow

$$\begin{aligned} S &\rightarrow Ab \\ A &\rightarrow aAb/B/C \\ B &\rightarrow bB/b \\ C &\rightarrow aC/a \end{aligned}$$

CFG = ()

Test

HW
7. (c)

$$L = \{a^n b^m : n \neq 2m\}$$

$$\left(\begin{array}{l} n = 2m \\ S \rightarrow aaSb / \lambda \end{array} \right)$$

aaabbb

n: even

$$S \rightarrow aaSb / \lambda$$

add a's / b's

$$S \rightarrow aaSb / A / B$$

$$A \rightarrow aAa$$

$$B \rightarrow bBb$$

m: odd

$$S \rightarrow aaS / aB$$

$$B \rightarrow bB / \lambda$$

$$S \rightarrow S_1 / S_2$$

$$S_1 \rightarrow aaS_1 b / A / B$$

$$A \rightarrow aAa$$

$$B \rightarrow bB / b$$

$$S_2 \rightarrow aaS_2 / aC$$

$$C \rightarrow bC / \lambda$$

$$S \rightarrow \epsilon / 0$$

$$E \rightarrow aaEb / \lambda$$

and with more a's or more b's

$$0 \rightarrow aa0 / aE$$

$$C \rightarrow bC / \lambda$$

\(\Rightarrow\)

$$E \rightarrow aaEb / A / B$$

$$A \rightarrow aAa$$

$$B \rightarrow bB / b$$

\(\{ \lambda \notin L(G) \}\)

\(\therefore \text{CFG} = (\dots)\)

Test: - - -

CH # 5.1
(EXERCISES)

7) HW

$$L = \{a^n b^m : 2n \leq m \leq 3n\}$$

$$\Rightarrow m = 2n \mid m = 3n$$

$$\therefore S \rightarrow aSbb \mid aSbbb \mid \lambda$$

(e) HW

$$L = \{\omega \in \{a,b\}^* : n_a(\omega) \neq n_b(\omega)\}$$

$$\left(\begin{array}{c} n_a(\omega) = n_b(\omega) \\ S \rightarrow sSa \mid bSa \mid \lambda \end{array} \right)$$

add a's or add b's \Rightarrow

$$S \rightarrow SS \mid aSb \mid bSa \mid a \mid bS \mid alb$$

(f) HW

$$L = \{\omega \in \{a,b\}^* : n_a(\gamma) \geq n_b(\gamma) : \gamma \text{ is prefix of } \omega\}$$

$$S \rightarrow SS \mid aSb \mid \lambda$$

(g) HW

$$L = \{\omega \in \{a,b\}^* : n_a(\omega) = 2n_b(\omega) + 1\}$$

$$n_a(\omega) = 2n_b(\omega)$$

$$S \rightarrow SS \mid aaaSb \mid bSaa \mid aSba \mid aSab \mid abSa \mid baSa \mid \lambda$$

$$n_a(\omega) = n_b(\omega) + 1$$

$$S \rightarrow SS \mid aaaSb \mid aSba \mid aSab \mid bSaa \mid baSa \mid abSa \mid a$$

Test:

aaab ; $S \rightarrow aaaSb \rightarrow aaab$ ✓

aab ; $S \rightarrow aSab \rightarrow \times$

$$n \geq 0, m \geq 0, k \geq 0.$$

HW 8

(a) $L = \{ a^n b^m c^k : n=m \text{ or } m \leq k \}$

$n=m, \textcircled{K}$

$$\begin{aligned} S_1 &\rightarrow AB \\ A &\rightarrow aAb/\lambda \\ B &\rightarrow cB/\lambda \end{aligned}$$

$m \leq k, \textcircled{M}$

$$\begin{aligned} S &\rightarrow AB \\ A &\rightarrow aA/\lambda \\ B &\rightarrow bBC \\ C &\rightarrow cC/\lambda \end{aligned}$$

$$\begin{aligned} S_2 &\rightarrow DE \\ D &\rightarrow aD/\lambda \\ E &\rightarrow bEF \\ F &\rightarrow cF/\lambda \end{aligned}$$

$$S \rightarrow S_1 / S_2$$

$n=m \textcircled{K}$

$$\begin{aligned} S_1 &\rightarrow AB \\ A &\rightarrow aAb/\lambda \\ B &\rightarrow cB/\lambda \end{aligned}$$

$m \leq k \textcircled{M}$

$$\begin{aligned} S_2 &\rightarrow CD \\ C &\rightarrow aC/\lambda \\ D &\rightarrow bDC/E \\ E &\rightarrow cE/\lambda \end{aligned}$$

$$\begin{array}{l} \hline m \leq k \\ m = k \\ \hline X \rightarrow bXc \\ \hline \text{add c's} \\ X \rightarrow bXc/c \\ C \rightarrow cC/\lambda \end{array}$$

HW (b)

$L = \{ a^n b^m c^k : n=m \text{ or } m \neq k \}$

$S \rightarrow S_1 / S_2$

$$\begin{aligned} S_1 &\rightarrow AB \\ A &\rightarrow aAb/\lambda \\ B &\rightarrow cB/\lambda \end{aligned}$$

$$\begin{array}{l} \hline m = k \\ \hline X \rightarrow bXc/\lambda \\ \hline \text{add b's / c's} \\ X \rightarrow bXc/Y/Z \\ Y \rightarrow bY/b \\ Z \rightarrow cZ/c \end{array}$$

$m \neq k$

$$\begin{aligned} S_2 &\rightarrow CD \\ C &\rightarrow aC/\lambda \\ D &\rightarrow bDC/E/F \\ E &\rightarrow bE/b \\ F &\rightarrow cF/c \end{aligned}$$

HW (c)

$L = \{ a^n b^m c^k : k = n+m \}$

$$\underbrace{aa \dots a}_n \underbrace{bb \dots b}_m \underbrace{ccc \dots c}_{n+m}$$

for every 'a' add a 'c'
for every 'b' add a 'c'

$$\begin{aligned} S &\rightarrow aSc / B \\ B &\rightarrow bSc / \lambda \end{aligned}$$

$G = (\{S, B\}, \{a, b, c\}, S, P)$

(d)
HW

$$L = \{a^n b^m c^k : n + 2m = k\}$$

aaa... aabb... bbcc... c
 m m m+2m

Every a add one c
 Every b add 2 c's

$$S \rightarrow aSc / B$$

$$B \rightarrow bBcc / \lambda$$

n:0 λ ✓
 m:0
 k:0 ac
 abccc ✓

(e)
HW

$$L = \{a^n b^m c^k : k = |n - m|\}$$

a... ab... bc... c
 n m excess a's or b's in the string so far.

$$k = n - m \quad / \quad k = m - n$$

$$\boxed{n = m + k} \quad \quad \quad \boxed{m = n + k}$$

$$S_1 \rightarrow aS_1c /$$

$$\rightarrow a b / \lambda$$

$$S_2 \rightarrow aS_2b / B$$

$$B \rightarrow bBc / \lambda$$

$$S \rightarrow S_1 / S_2$$

HW

(f) $L = \{w \in \Sigma^* : n_a(w) + n_b(w) \neq n_c(w)\}$

$n + m < k$ $n + m > k$
 \Rightarrow add any no. of c's add any no. of a's or b's or both

$$S \rightarrow S_1 / S_2$$

⊗ (9) $L = \{a^n b^m c^k, k \neq n+m\}$

HW

$$\left(\begin{array}{l} k = n+m \\ S \rightarrow aSc / B \\ B \rightarrow bBc / \lambda \end{array} \right)$$

$$(S \rightarrow S_1 / S_2)$$

$n+m < k$
add any no. of c's

$n+m > k$

~~$\{a, b, aa, ab, ba, bb, abc, \dots\}$~~

$$\left(\begin{array}{l} n = m = k \\ S \rightarrow aSc / B \\ B \rightarrow bBc / \lambda \end{array} \right)$$

$$\left(\begin{array}{l} n = m = k \\ S \rightarrow aSc / B \\ B \rightarrow bBc / \lambda \end{array} \right)$$

add atleast one a or more
add atleast one b or more

$$\boxed{\begin{array}{l} S \rightarrow aSc / cS / c / B \\ B \rightarrow bSc / \lambda \end{array}}$$

Test abcc: $aSc \rightarrow abSc \times$

abccc ✓

acc ✓

\Rightarrow

$$\boxed{\begin{array}{l} S_2 \rightarrow aS_2c / aS_2 / bS_2 / a / b / B \\ B \rightarrow bBc / \lambda \end{array}}$$

Test

a: $S \rightarrow a \checkmark$

aabcc: $aSc \rightarrow aaSc \rightarrow aabccc \times$

aabcc: $aSc \rightarrow aaSc \rightarrow aabcc \checkmark$

8

(h)
HW

$$L = \{a^n b^n c^k : k \geq 3\}$$

$$\left(\begin{array}{l} a^n b^n c^k : n, k \geq 0 \\ S \rightarrow AB \\ A \rightarrow aAb / \lambda \\ B \rightarrow cB / \lambda \end{array} \right)$$

$$k \geq 3$$

$$B \rightarrow cB / ccc$$



minimum 3 c's or more

$$\begin{aligned} \therefore S &\rightarrow AB \\ A &\rightarrow aAb / \lambda \\ B &\rightarrow cB / ccc \end{aligned}$$

Test

$$ccc : S \rightarrow AB \rightarrow B \rightarrow ccc \checkmark$$

$$abccc : S \rightarrow abB \rightarrow abccc \checkmark$$

9. ST $L = \{w \in a, b, c^* : |w| = 3n a(w)\}$ is a CFG.

$$\begin{array}{l} a^n \\ b^m \\ c^k \end{array}$$

$$n+m+k = 3n$$

$$m+k = 2n$$

∃ for every b an a

∃ for every c an a

(no order ∴ Σ^*)

$$\begin{aligned} \therefore S &\rightarrow SS / aSc / B \\ B &\rightarrow bBc / cBb / \lambda \end{aligned}$$

Test

$$\begin{array}{l} S \rightarrow aSX / bSY / cSZ \\ X \rightarrow bc / cb / bb / cc \\ Y \rightarrow ac / ca / ab / ba \\ Z \rightarrow ab / ba / ac / ca \end{array}$$

sub are

$$m+k = 2n$$

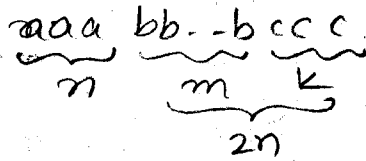

$S \rightarrow ABC$

$A \rightarrow$

$$m+k = 2n$$

$$2 [n_a(w)] = n_b(w) + n_c(w)$$

Every a has 2 more symbols
 \downarrow
 Either [b/c]

$\Rightarrow S \rightarrow aSX / bSY / cSZ / SS / \lambda$
 $X \rightarrow bb / cc / bc / cb \rightarrow$ already / a
 $Y \rightarrow ab / ba / ac / ca$
 $Z \rightarrow ac / ca / ab / ba$

Test:

$n_a(w) = 1$	$w = abc$	$S \rightarrow aSX \rightarrow abc \checkmark$
$3n_a(w) = 3$	$w = bac$	$S \rightarrow bSY \rightarrow bac \checkmark$
$n_a(w) = 2$	$w = aabbbb$	$S \rightarrow SS \rightarrow aSX \rightarrow$
$3n_a(w) = 6$		$aaSXX \rightarrow aabbbb \checkmark$

5.1

11. CFG? $L = \{a^n w w^R b^n : w \in \Sigma^*, n \geq 1\}$ $\Sigma = \{a, b\}$

$$\left(\begin{array}{l} ww^R \text{ on } \Sigma = \{a, b\} : n \geq 1 \\ S \rightarrow aSa / bSb / a / b \end{array} \right)$$

$a \checkmark$ $aa \checkmark$
 $b \checkmark$ $abab \checkmark$
 $abba \checkmark$

$$S \rightarrow aSb / W$$

$$W \rightarrow aWa / bWb / a / b$$

Test
 $aabab : S \rightarrow aSb \rightarrow aaWab \rightarrow aabab \checkmark$
 $abab : S \rightarrow aSb \rightarrow X$

13. $L = \{a^n b^n : n \geq 0\}$

- ST L^2 is CFG
- ST L^k is CFG $\forall k \geq 1$
- ST $\Sigma^* \cap L^*$ are CFG.

$$L^2 : a^n b^n a^m b^m$$

$$L^k : \frac{a^n b^n}{1} \frac{a^m b^m}{2} \dots \frac{a^p b^p}{k}$$

$$S \rightarrow AA$$

$$A \rightarrow aAb / \lambda$$

$$S \rightarrow A_1 A_2 \dots A_{k+1}$$

$$A \rightarrow aAb / \lambda$$

$$\Sigma^* : \Sigma^* = a^* b^* \rightarrow \text{CFG}$$

$$S \rightarrow SS / aSb / bSa / \lambda$$

= CFG

= CFG

$$L^* : \lambda \in L, L^0 \text{ CFG}$$

$$L^k \in \text{CFG}$$

$$\therefore L^* \text{ is CFG}$$

(19)

Show derivation Tree for aabbbb

$$S \rightarrow AB/\lambda$$

$$A \rightarrow aB$$

$$B \rightarrow Sb$$

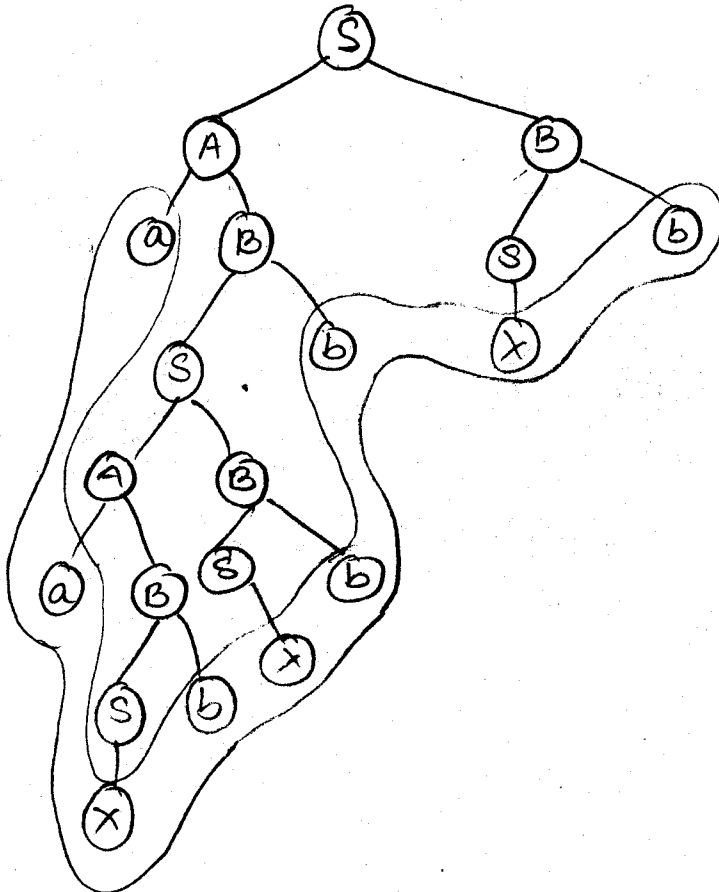

* **Parsing:** finding a sequence of productions by which $w \in L(G)$ is derived.

Exhaustive search has flaws.

- ① Tedious
- ② it is possible that it never terminates for a $w \notin L(G)$

* **SIMPLE GRAMMAR:**

A context free Grammar $G = (V, T, S, P)$ is said to be a simple Grammar or s-grammar if all productions are of the form

$$\rightarrow A \rightarrow ax.$$

- $A \in V, a \in T, x \in V^*$

\rightarrow Any pair (A, a) occurs at most once in P .

* A CFG is said to be **ambiguous** if there exists some $w \in L(G)$ that has at least two distinct derivation trees

*1) $S \rightarrow aS / bSS / c$ ✓ S-Grammar

∵ $A \rightarrow ax$, (A, a) never repeats

$S \rightarrow aS / bSS / aSS / c$ ✗ not S-Grammar

∵ (A, a) repeat through $A \rightarrow ax$

* $S \rightarrow aSb / SS / \lambda$

w: aabb

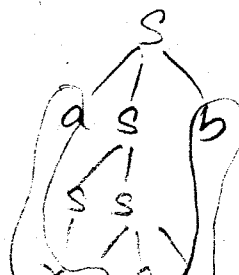
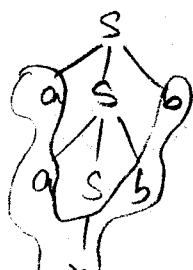

∴ ambiguous.

→ One way to resolve ambiguity is

① Associate precedence rules \Rightarrow change semantics

→ Another way is to rewrite the Grammar.

→ If Every Grammar that generates L is ambiguous, then L is called Inherently ambiguous.

EXERCISES

find an \exists Grammar for $L(aaa^*b + b)$

aaa^*b .

$A \rightarrow ax$
 $(A, a) \times$

$S \rightarrow aaAb / b$

$A \rightarrow aA / \lambda$

$S \rightarrow aaAb / b$
 $A \rightarrow aA / \lambda$

$S \rightarrow aA / b$

$A \rightarrow a$

$B \rightarrow aB$

$(aaa^*b + b) = (aab + b) + aaa^*b$
 \downarrow aa^* \downarrow $\text{min one } a$

aab

$S \rightarrow aX$

$X \rightarrow aY$

$Y \rightarrow b$

$aaa^*b + b$

$S \rightarrow aX / b$

$X \rightarrow aY$

$Y \rightarrow aY / b$

Test

$aab: S \rightarrow aX \rightarrow aaY \rightarrow aab \checkmark$

$aaab: S \rightarrow aX \rightarrow aaY \rightarrow aaaY \rightarrow aaab \checkmark$

①
HW

2. HW

find an s-grammar for $L = \{a^n b^n : n \geq 1\}$

$$\{a^n b^n \mid n \geq 1\} \quad \lambda \notin L(G)$$

$$S \rightarrow aSb / ab$$

$$B \rightarrow b$$

$$S \rightarrow aSB / aB$$

(S,a) X

~~$$S \rightarrow aB / \lambda$$~~
~~$$B \rightarrow S / \lambda$$~~

$$S \rightarrow aA$$

$$A \rightarrow b / aAB$$

$$B \rightarrow b$$

3

find an s-grammar for $L = \{a^n b^{n+1} : n \geq 2\}$

$$a^n b^{n+1} : n \geq 2$$

$$S \rightarrow aSb / aabbb$$

$$a^n b^{n+1} : n \geq 0$$

$$S \rightarrow aSb / b$$

$$n \geq 2$$

Substitute $n=0$.

aabbbb :

$x \rightarrow ay$
$y \rightarrow az$
$z \rightarrow bw$
$w \rightarrow bv$
$v \rightarrow b$

$$\underbrace{\quad \quad \quad}_{a * n} \cdot aabbbb \cdot \underbrace{\quad \quad \quad}_{b * n}$$

$S \rightarrow aA$
$A \rightarrow aB$
$B \rightarrow bX / aBY$
$X \rightarrow bY$
$Y \rightarrow b$

\uparrow
 $a^n b^n$

Test

aabbbb: $S \rightarrow aA \rightarrow aaB \rightarrow aabX \rightarrow aabbY \rightarrow aabbbb \checkmark$

aaabbbb: $S \rightarrow aA \rightarrow aaB \rightarrow aaaBY \rightarrow aaabXY \rightarrow aaabbbYY \rightarrow aaabbbb \checkmark$

6 HW

Show that the following Grammar is ambiguous:

$S \rightarrow AB / aaB$
 $A \rightarrow a / Aa$
 $B \rightarrow b$

$w = aab$

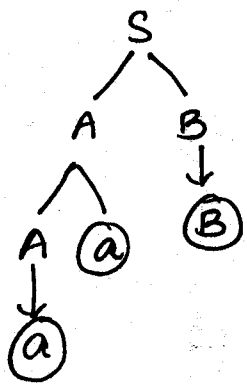

$w = aab$

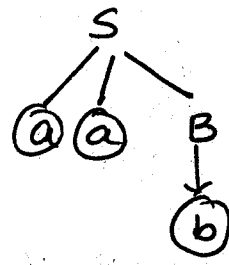

$\exists w = aab$ st \exists two distinct derivation trees as above.
 \therefore The Grammar is AMBIGUOUS.

7 HW

Construct unambiguous grammar for above Grammar.

~~$S \rightarrow aaB$ is repetitive.~~

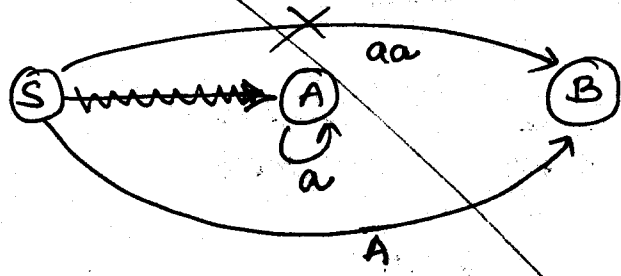

~~\therefore~~
 ~~$S \rightarrow AB$~~
 ~~$A \rightarrow a / Aa$~~
 ~~$B \rightarrow b$~~

~~$\Rightarrow a^*b : \{a^n b : n \geq 1\}$~~

a^*b

- ab
- aab
- $aaab$

$S \rightarrow aA$
 $A \rightarrow b / aX$
 $X \rightarrow aX / b$

~~\therefore~~
 ~~$S \rightarrow aA / AB$~~
 ~~$S \rightarrow aA$~~
 ~~$A \rightarrow aA / b$~~

~~$S \rightarrow aS / b$~~

HW
⑧

Give derivation tree for $((c+a)*c)+a+b$ using

- $E \rightarrow T$
- $T \rightarrow F$
- $F \rightarrow |$
- $E \rightarrow E+T$
- $T \rightarrow T*F$
- $F \rightarrow (E)$
- $I \rightarrow a/b/c$

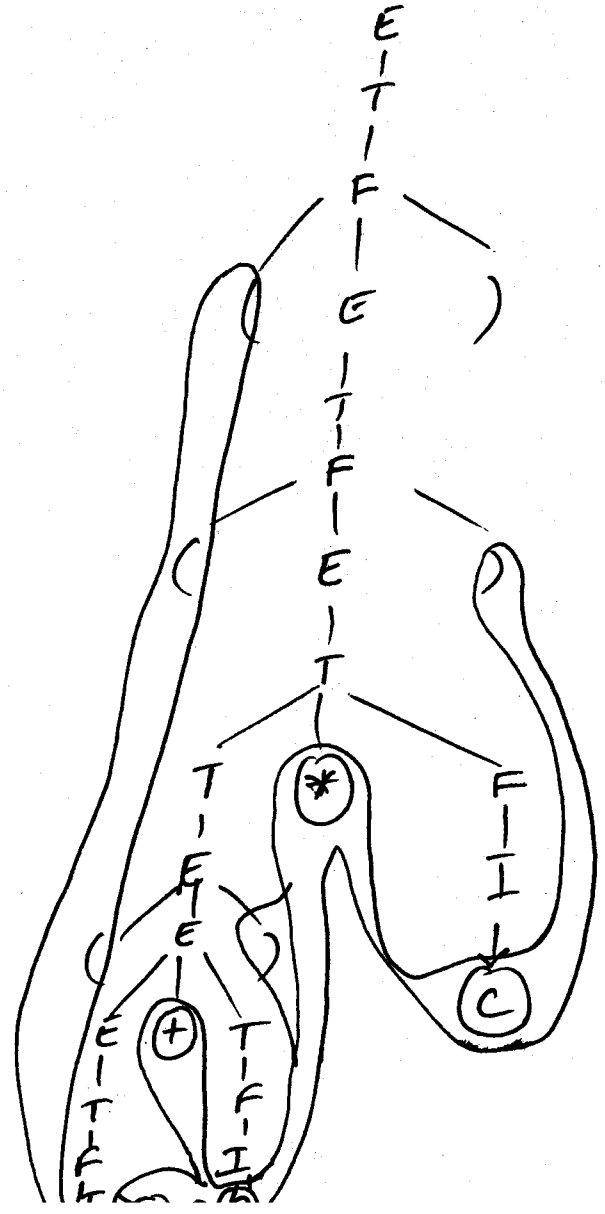
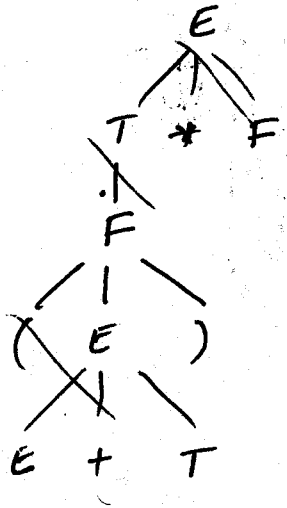

$((c+a)*c)$

10

Give unambiguous grammar equivalent to set of all regular expressions on $\Sigma = \{a, b\}$

$\{\lambda, a, b, ab, ba, abb, \dots\}$
 $\downarrow \downarrow \downarrow \downarrow$
 SS

$(a+b)^*$

$S \rightarrow aS / bS / \lambda$

$S \rightarrow aS / bS / a / b$

$S \rightarrow aSX / bSY$

$X \rightarrow a / b$

$ab \checkmark$

$abab \checkmark$

$(S \rightarrow aSb / bSa / SS / a / b / \lambda)$
 ambiguous, strings $\in \{a, b\}^*$

RE:

$S \rightarrow SS / aSb / bSa / a / b$

?

12 S.T the language $L = \{ww^R : w \in \{a, b\}^*\}$ is not inherently ambiguous.

ww^R :

$S \rightarrow aSa / bSb / a / b / \lambda$

test abx $abbaabba \checkmark$ $aa \checkmark$
 $aba \checkmark$ $\lambda \notin L(a)$

all grammars are ambiguous

ww^R

$S \rightarrow aSa / bSb / a / b$

$S \rightarrow aSX / bSY$

$X \rightarrow a$

$Y \rightarrow b$

~~$S \rightarrow aSa / bSb / a / b / \lambda$~~

~~$S \rightarrow aSa / bSb / a / b / aa / bb$~~

~~$S \rightarrow aSa / bSb / aa / bb / aaa / bab / aba / bbb$~~

~~$S \rightarrow aSa / bSb / aaa / aba / bbb / bab / aa / bb$~~

① Eliminate λ

② eliminate UNIT-PS

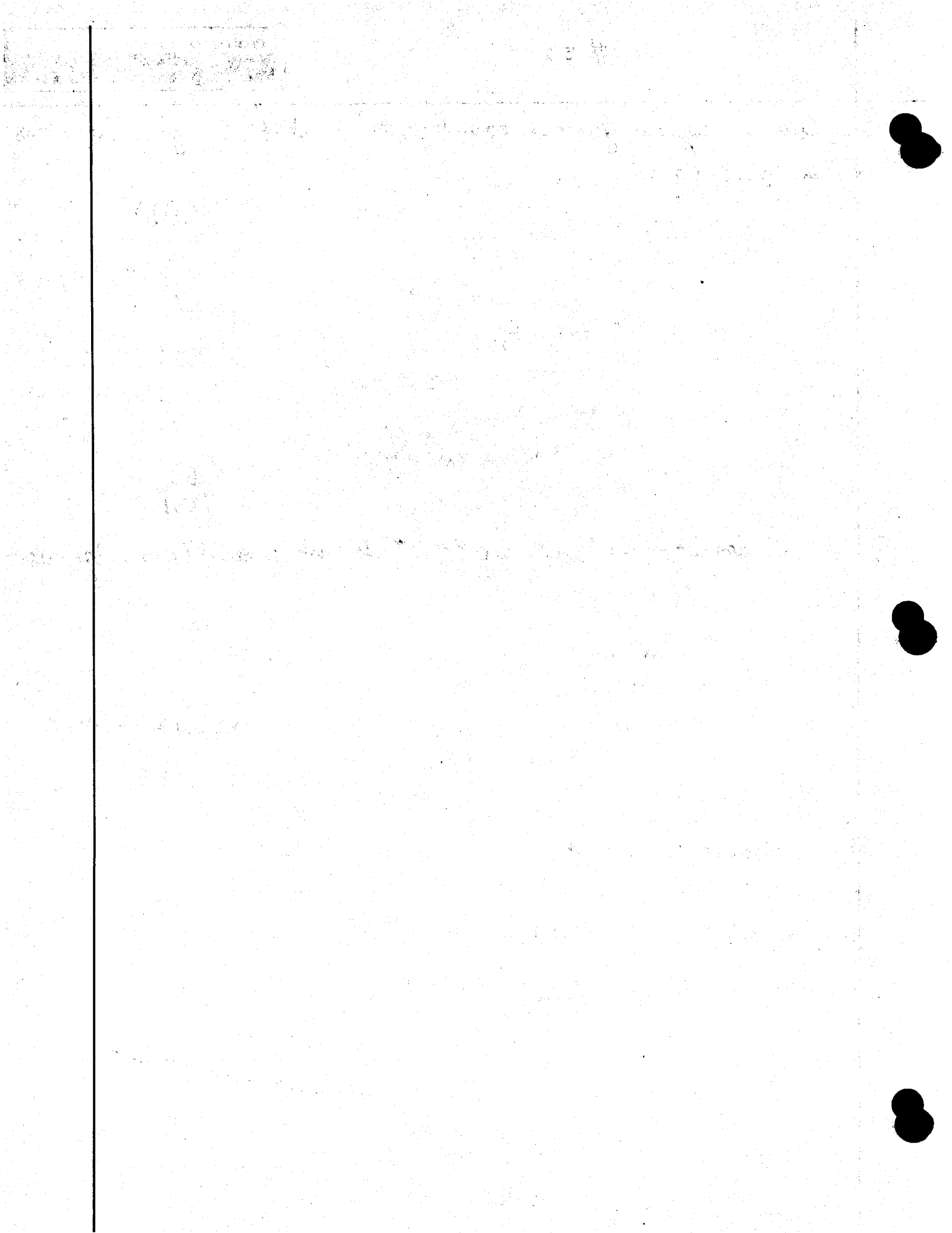

Simplification of CFG & Normal forms

Eg: 6.1

$$G = (\{A, B\}, \{a, b, c\}, A, P)$$

$$A \rightarrow a|aaA|abBc$$

$$B \rightarrow abbA|b$$

$$A \rightarrow a|aaA|ababbbAc|abbc$$

Eg: 6.2

$$S \rightarrow A$$

$$A \rightarrow aA|\lambda$$

$$B \rightarrow bA$$

$$S \rightarrow A$$

$$A \rightarrow aA|\lambda$$

$$S \rightarrow A$$
$$A \rightarrow aA|a$$

$$S \rightarrow A$$

$$A \rightarrow aA|a$$

6.3

$$S \rightarrow aS|A|C$$

$$A \rightarrow a$$

$$B \rightarrow aa$$

$$C \rightarrow acb$$

$$S \rightarrow aS|a|C$$

$$C \rightarrow acb$$

$$S \rightarrow aS|a$$

6.4

$$S \rightarrow aS_1b$$

$$S_1 \rightarrow aS_1b|\lambda$$

$$S \rightarrow aS_1b|ab$$

$$S_1 \rightarrow aS_1b|ab$$

6.5

find CFG without λ -productions

$$S \rightarrow ABaC$$

$$A \rightarrow BC$$

$$B \rightarrow b|\lambda$$

$$C \rightarrow D|\lambda$$

$$D \rightarrow d$$

$$\textcircled{1} \lambda \notin L(G)$$

$$\textcircled{2} V_N : \{A, B, C\}$$

$$S \rightarrow ABaC|BaC|AaC|ABa|aC|Ba|Aa|a$$

$$A \rightarrow BC|B|C$$

$$B \rightarrow b$$

$$C \rightarrow D$$

$$D \rightarrow d$$

Rules to Eliminate λ -Productions

- ① check that $\lambda \notin L(G)$
- ② $\forall v_i = \{ \dots \}$
- ③ Eliminate all λ -productions
- ④ make all combinations of nullable variables.

Rules to eliminate UNIT-Productions

STEP #1: find dependency Graph for unit-Productions.

nodes \rightarrow variable

connections $\&$ where Unit Production \bar{A} .

STEP #2:

$$S \xrightarrow{*} A \quad A \xrightarrow{*} B$$

$$S \xrightarrow{*} B$$

$$B \xrightarrow{*} A$$

STEP #3:

Grammar without
UNIT-Productions

+

make
Extensions

Eg: 6.6

$$S \rightarrow Aa/B$$

$$B \rightarrow A/bb$$

$$A \rightarrow a/bc/B$$

$$S \rightarrow B$$

$$B \rightarrow A$$

$$A \rightarrow B$$

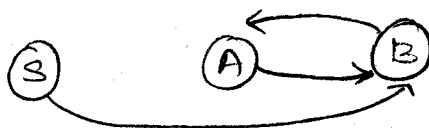

$$S \xrightarrow{*} A$$

$$A \xrightarrow{*} B$$

$$B \xrightarrow{*} A$$

$$S \xrightarrow{*} B$$

$$S \rightarrow Aa \quad / a/bc/bb$$

$$B \rightarrow bb \quad / a/bc$$

$$A \rightarrow a/bc \quad / bb$$

[EXERCISES]

HW ②

$A \rightarrow a|aaA|abBc$

$B \rightarrow abbA|b$

\Rightarrow

$A \rightarrow a|aaA|$ ~~$ababbaaaA$~~

$ababbac$ / ~~$ababbaaAc$~~ /

~~$ababbaa$~~ $abbc$

Derivation tree for $w = ababbac$?

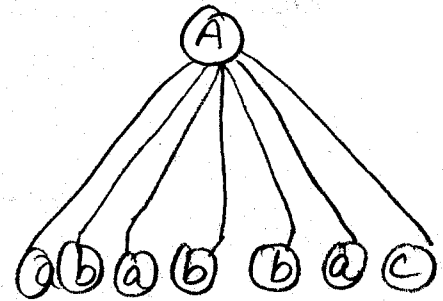
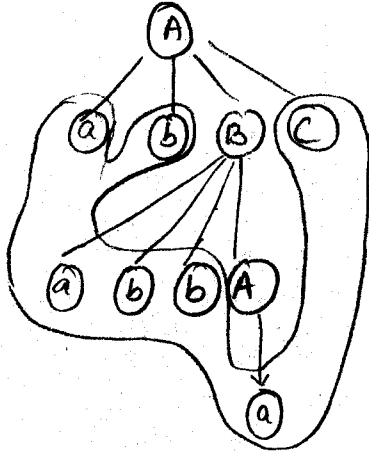

$w = ababbac$

$w = ababbac$

HW ⑤

Eliminate all useless productions for the Grammar.

$S \rightarrow aS|AB$

$A \rightarrow bA$

$B \rightarrow AA$

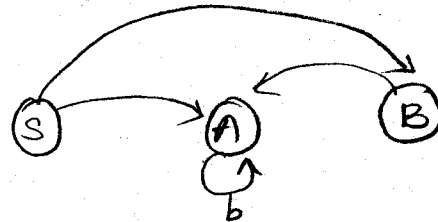

Substitution:

$S \rightarrow aS|AAA$

~~$A \rightarrow bA$~~

~~$B \rightarrow AA$~~

$S \rightarrow aS|AAA$

~~$A \rightarrow bA$~~

never ends

$S \rightarrow aS$

\downarrow

never ends

$L = \{w = a^{\infty} b^{\infty} \mid w \in \Sigma a b^* \}$

HW ⑥

Eliminate Useless Productions from

$S \rightarrow a/aA/B/C$
 $A \rightarrow aB/\lambda$
 $B \rightarrow Aa$
 $C \rightarrow cCD$
 ~~$D \rightarrow ddd$~~

Substitution:

~~$S \rightarrow a/aA/B/cCddd$~~
 ~~$A \rightarrow aB/\lambda$~~
 ~~$B \rightarrow Aa$~~
 ~~$C \rightarrow cCddd$~~

$S \rightarrow a/aA/Aa$
 $A \rightarrow aAa/\lambda$

Eliminate λ -Productions from

$S \rightarrow AaB/aaB$
 $A \rightarrow \lambda$
 $B \rightarrow bbA/\lambda$

- ① $\lambda \notin L(G)$
- ② $V_N = \{A, B\}$

$S \rightarrow AaB/aaB$ $B \rightarrow bbA/\lambda$ $A \rightarrow \lambda$	/	$S \rightarrow aB/aaB/a/aa$ $B \rightarrow bb$
-----------------------------------------------------------------------------------	---	---------------------------------------------------

$\therefore S \rightarrow aB/aaB/a/aa$
 $B \rightarrow bb$

Simplified:-

$S \rightarrow abb/aabb/a/aa$

(Ex)

8

Remove all UNIT-Productions, useless Productions & λ -Productions

$S \rightarrow aA/aBB$
 $A \rightarrow aaA/\lambda$
 $B \rightarrow bB/bbC$
 $C \rightarrow B$

*λ -production
elimination*

- ① $\lambda \notin L(G)$
- ② $V_N = \{A\}$

$S \rightarrow aA/aBB/a$
 $A \rightarrow aaA/aa$
 $B \rightarrow bB/bbC$
 $C \rightarrow B$

*Unit Production
Removal*

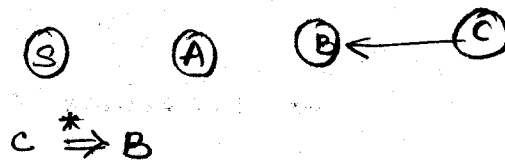

$S \rightarrow aA/aBB/a$ $A \rightarrow aaA/aa$ $B \rightarrow bB/bbC$	B
----------------------------------------------------------------------------------------------------	-----

~~$S \rightarrow aA/aBB/a$~~
 $A \rightarrow aaA/aa$

$S \rightarrow aA/a$
 $A \rightarrow aaA/aa$

What does the language generate?

$\{a^n\} \cup \{a^{2n+1}\} \quad (aa)^* a$

9

Eliminate UNIT-Productions from 6

$S \rightarrow a/aA/B/C$
 $A \rightarrow aB/\lambda$
 $B \rightarrow Aa$
 $C \rightarrow cCD$
 $D \rightarrow ddd$

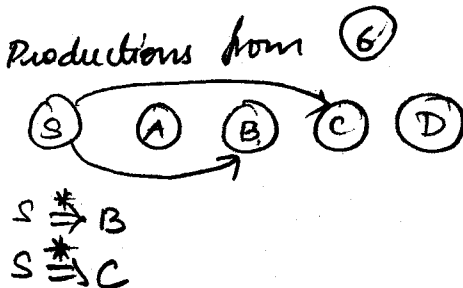

$S \rightarrow a/aA/Aa/cCD$
 $A \rightarrow aB/\lambda$
 $B \rightarrow Aa$
 $C \rightarrow cCD$
 $D \rightarrow ddd$

12

Remove λ -Productions

~~$S \rightarrow aS / \lambda$~~
 ~~$A \rightarrow a$~~
 ~~$B \rightarrow aa$~~
 ~~$C \rightarrow acb$~~

$S \rightarrow asb / SS / \lambda$

$\emptyset \quad \lambda \in L(a)$

$\{sa + \{\lambda\} \} sa \longrightarrow S \rightarrow asb / SS / ab$

CHAPTER 6-2

CHOMSKY NORMAL FORM:

$A \rightarrow BC$

$A \rightarrow a$

$\lambda \notin L(a)$

\rightarrow restrictions on length of Production.

$\{A, B, C\} \in V$

$a \in T$

$S \rightarrow AS / a$

$A \rightarrow SA / b$

\notin CNF

$S \rightarrow AS / AAS$

$A \rightarrow SA / aa$

\in CNF

Eg 6.8

Convert the Grammar to CNF

$S \rightarrow ABa$

$A \rightarrow aab$

$B \rightarrow AC$

$X \rightarrow a \quad Z \rightarrow C$

$Y \rightarrow b$

$S \rightarrow ABX$

$A \rightarrow XXY$

$B \rightarrow AZ$

$X \rightarrow a$

$Y \rightarrow b$

$Z \rightarrow C$

$S \rightarrow AC$

$C \rightarrow BX$

$A \rightarrow XD$

$D \rightarrow XY$

$B \rightarrow AZ$

$X \rightarrow a$

$Y \rightarrow b$

$Z \rightarrow C$

GRIEBACH NORMAL FORM:

- restriction NOT on length of Production
- but on POSITIONS in which terminals & variables can appear

$$A \rightarrow a\alpha$$

$$a \in T \quad \alpha \in V^*$$

- looks similar to s-Grammar
- But no-restriction on (A,a) of Productions.

Eg: 6.9

$$\left. \begin{array}{l} S \rightarrow AB \\ A \rightarrow aA / bB / b \\ B \rightarrow b \end{array} \right\} \begin{array}{l} \text{not GNF} \\ A \rightarrow aX \end{array}$$

$$\left. \begin{array}{l} S \rightarrow aAB / bBB / bB \\ A \rightarrow aA / bB / b \\ B \rightarrow b \end{array} \right\} \in \text{GNF.}$$

Eg: 6.10

Convert the Grammar $S \rightarrow abSb / aa$ into GNF.

$$X \rightarrow a$$

$$Y \rightarrow b$$

$$S \rightarrow aYSY / aX$$

$$X \rightarrow a$$

$$Y \rightarrow b$$

for every cfa $G, \lambda \in L(G)$

\exists Equivalent \bar{G} , in GNF.

EXERCISES -
CH #62

② Convert to CNF

$$S \rightarrow asb/ab$$

$$S \rightarrow XSX/XY$$

$$X \rightarrow a$$

$$Y \rightarrow b$$

CNF

$$A \rightarrow BC$$

$$A \rightarrow a$$

$$S \rightarrow XA/XY$$

$$A \rightarrow SY$$

$$X \rightarrow a$$

$$Y \rightarrow b$$

ECNF

HW ③

Convert to CNF:

$$S \rightarrow aSaA/A$$

$$A \rightarrow abA/b$$

substitution:

$$S \rightarrow aSaA/abA/b$$

$$A \rightarrow abA/b$$

CNF:

$$A \rightarrow BC$$

$$A \rightarrow a$$

$$S \rightarrow aSXA/aYA/b$$

$$A \rightarrow aYA/b$$

$$X \rightarrow a$$

$$Y \rightarrow b$$

$$S \rightarrow XB/XC/b$$

$$A \rightarrow XC/b$$

$$B \rightarrow SD$$

$$C \rightarrow YA$$

$$D \rightarrow XA$$

$$X \rightarrow a$$

$$Y \rightarrow b$$

HW

④ Convert to CNF

$$S \rightarrow abAB$$

$$A \rightarrow bAB/\lambda$$

$$B \rightarrow BAa/A/\lambda$$

Elimination $\lambda \notin L(G)$

$$V_N: \{A, B\}$$

$$S \rightarrow abAB/abA/abB$$

$$A \rightarrow bAB/bA/bB$$

$$B \rightarrow BAa/A/Ba/Aa$$

$$S \rightarrow \overline{X}YAB/\overline{X}YA/\overline{X}YB$$

$$A \rightarrow \overline{Y}AB/\overline{Y}A/\overline{Y}B$$

$$B \rightarrow BAX/BX/AX/\overline{Y}AB/\overline{Y}A/\overline{Y}B$$

$$X \rightarrow a$$

$$Y \rightarrow b$$

$$B \rightarrow BAa/Ba/Aa/bAB/bA/bB$$

$$S \rightarrow XCB/XC/XD$$

$$A \rightarrow CB/YA/YB$$

$$B \rightarrow EX/BX/AX/CB/YA/YB$$

$$C \rightarrow YA \quad E \rightarrow BA \quad Y \rightarrow b$$

$$S \rightarrow FB/XC/XD$$

$$A \rightarrow CB/YA/YB$$

$$B \rightarrow EX/BX/AX/CB/YA/YB$$

$$C \rightarrow YA$$

$$D \rightarrow YB$$

$$E \rightarrow BA$$

$$F \rightarrow XC$$

$$X \rightarrow a$$

$$Y \rightarrow b$$

CCNF

⑤

Convert to CNF:

$$S \rightarrow AB/aB$$

$$A \rightarrow aab/\lambda$$

$$B \rightarrow bbA$$

 $\lambda \notin (u)$ λ -elimination $V_N: \{A\}$

$$S \rightarrow AB/aB/B$$

$$A \rightarrow aab$$

$$B \rightarrow bbA/bb$$

Substitution

$$S \rightarrow AB/aB/bbA/bb$$

$$A \rightarrow aab$$

$$B \rightarrow bbA/bb$$

$$S \rightarrow AB/XB/\underline{XYB}/YY$$

$$A \rightarrow \underline{XXY}$$

$$B \rightarrow \underline{YYA}/YY$$

$$X \rightarrow a \quad Y \rightarrow b$$

$$S \rightarrow AB/XB/CB/YY$$

$$A \rightarrow DY$$

$$B \rightarrow CA/YY$$

$$C \rightarrow YY$$

$$D \rightarrow XX$$

HW 7

Draw dependency Graph for

$S \rightarrow abAB$
 $A \rightarrow bAB/\lambda$
 $B \rightarrow BAa/A/\lambda$

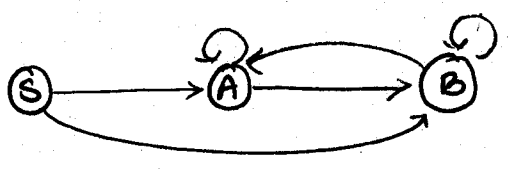

10 Convert to GNF

$S \rightarrow asb/bSa/a/b$

$S \rightarrow aX$
GNF

$S \rightarrow aSY/bSX/a/b$
 $X \rightarrow a$
 $Y \rightarrow b$

11 Convert to GNF

$S \rightarrow aSb/lab$

$S \rightarrow aSY/aY$
 $Y \rightarrow b$

HW 12

Convert to CNF

$S \rightarrow ab/aS/aas$

$S \rightarrow aY/aS/aXS$
 $X \rightarrow a$
 $Y \rightarrow b$

13 Convert to CNF

$S \rightarrow ABb/a$
 $A \rightarrow aaA/B$
 $B \rightarrow bAb$

substitution

$S \rightarrow aaABb/BBb/a$
 $A \rightarrow aaA/bAb$
 $B \rightarrow bAb$

$S \rightarrow aaABb/bAbBb/a$
 $A \rightarrow aaA/bAb$
 $B \rightarrow bAb$

$S \rightarrow aXABY/bAYBY/a$
 $A \rightarrow aXA/bAY$
 $B \rightarrow bAY$
 $X \rightarrow a$

*)

Palindrome: CNF = ?

$\lambda \notin L(G)$

\downarrow
 $ww^R \rightarrow \cancel{aba} \quad \cancel{bab} \quad \text{add } a/b$

\downarrow
 $S \rightarrow aSa / bSb / \lambda / a/b$

$S \rightarrow aSa / bSb / aa / bb$

$S \rightarrow XSX / YSY / XX / YY / a/b$

$X \rightarrow a$

$Y \rightarrow b$

$S \rightarrow XA / YB / XX / YY / a/b$

$A \rightarrow SX$

$X \rightarrow a$

$Y \rightarrow b$

$B \rightarrow SY$

*

$L = \{a^n : n > 1\}$ CNF = ?

$S \rightarrow aaaaS / aaaa$

$S \rightarrow AAAAS / AAAA$

$A \rightarrow a$

$S \rightarrow XXS / XX$

$X \rightarrow AA$

$A \rightarrow a$

$S \rightarrow YS / XX$

$X \rightarrow AA$

$Y \rightarrow XX$

$A \rightarrow a$

Npda: Nondeterministic Pushdown Automata:

$$M = (Q, \Sigma, \Gamma, \delta, q_0, z, F)$$

Ex: 7.1

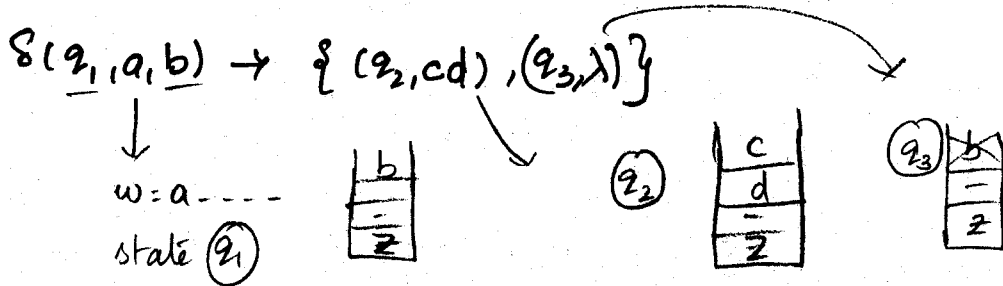

Ex: 7.2

$$Q = \{q_0, q_1, q_2, q_3\}$$

$$\Sigma = \{a, b\}$$

$$\Gamma = \{0, 1\}$$

$$z = 0$$

$$F = \{q_3\}$$

$$\delta(q_0, a, 0) = \{(q_1, 10), (q_3, \lambda)\}$$

$$\delta(q_0, \lambda, 0) = \{(q_3, \lambda)\}$$

$$\delta(q_1, a, 1) = \{(q_1, 11)\}$$

$$\delta(q_1, b, 1) = \{(q_2, \lambda)\}$$

$$\delta(q_2, b, 1) = \{(q_2, \lambda)\}$$

$$\delta(q_2, \lambda, 0) = \{(q_3, \lambda)\}$$

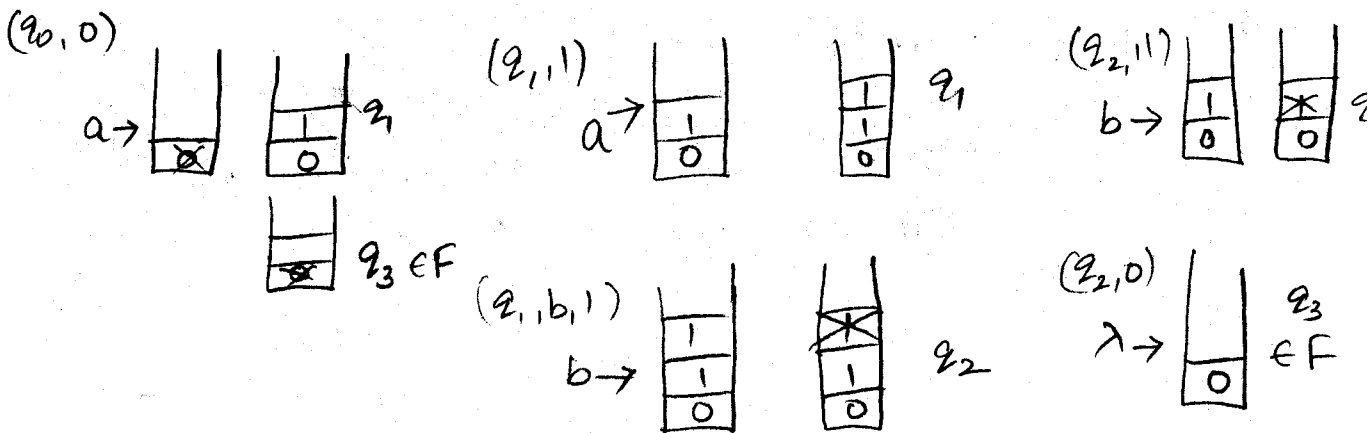

$$a \cup \{a^n b^n : n \geq 0\}$$

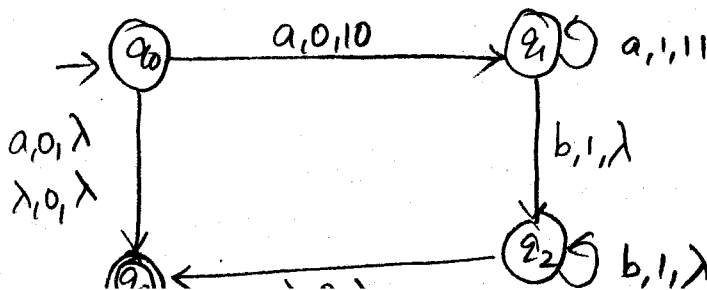

$L = \{a^n b^n a^n : n \geq 0\}$

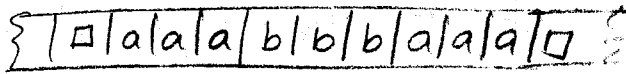

$\delta_0^{M_1}:$
 $a \rightarrow x$
 $b \rightarrow y$
 $\square \rightarrow z$

~~aa bb a~~

~~aa bba~~

~~ab a~~

$\delta(q_0, a) = (q_1, \square, R)$

$\delta(q_1, a) = (q_1, a, R)$

$\delta(q_1, b) = (q_2, b, R)$

$\delta(q_2, b) = (q_2, b, R)$

$\delta(q_2, a) = (q_3, a, L)$

$\delta(q_3, b) = (q_3, a, R)$

$\delta(q_3, a) = (q_3, a, R)$

$\delta(q_3, \square) = (q_4, \square, L)$

$\delta(q_4, a) = (q_5, \square, L)$

$\delta(q_5, a) = (q_6, \square, L)$

$\delta(q_6, a) = (q_7, a, L)$

$\delta(q_7, a) = (q_7, a, L)$

$\delta(q_7, b) = (q_7, b, L)$

$\delta(q_7, \square) = (q_0, \square, R)$

$\delta(q_6, \square) = (q_6, \square, R)$

$\delta(q_0, \square) = (q_6, \square, R)$

not λ

$M = ($

Test $w = aba : \in L$

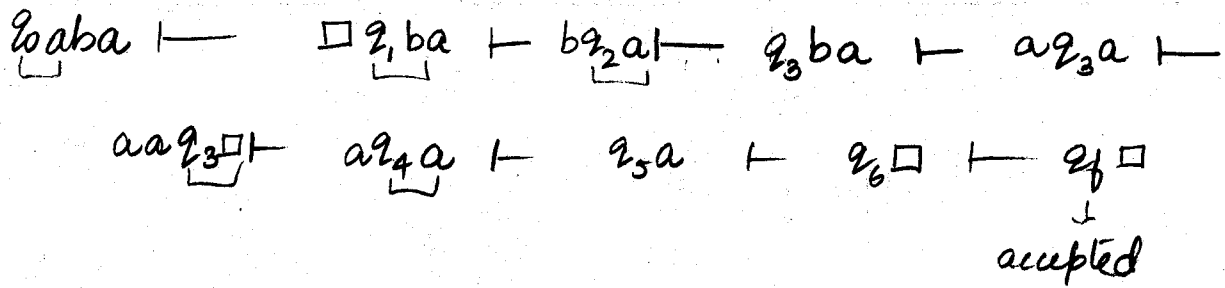

* Design TM that accepts PALINDROME language.

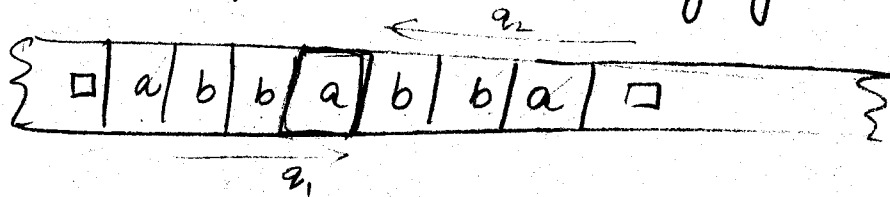

LIRN

$$\delta(q_0, a) = (q_1, \square, R)$$

$$\delta(q_0, b) = (q_2, \square, R)$$

$$\delta(q_1, a) = (q_1, a, R)$$

$$\delta(q_2, b) = (q_2, b, R)$$

$$\delta(q_1, b) = (q_1, b, R)$$

$$\delta(q_2, a) = (q_2, a, R)$$

$$\delta(q_1, \square) = (q_3, \square, L)$$

$$\delta(q_2, \square) = (q_5, \square, L)$$

$$\delta(q_3, a) = (q_4, \square, L)$$

$$\delta(q_5, b) = (q_4, \square, L)$$

$$\delta(q_4, a) = (q_4, a, L)$$

$$\delta(q_4, b) = (q_4, b, L)$$

$$\delta(q_4, \square) = (q_0, \square, R)$$

$$\delta(q_0, \square) = (q_6, \square, R)$$

even string

$$\delta(q_5, \square) = (q_6, \square, R)$$

$$\delta(q_3, \square) = (q_6, \square, R)$$

} odd string
middle = a/b

M: (-)

Test: ababa

instead of expecting another
a/b to delete, if no symbol
→ accepted.

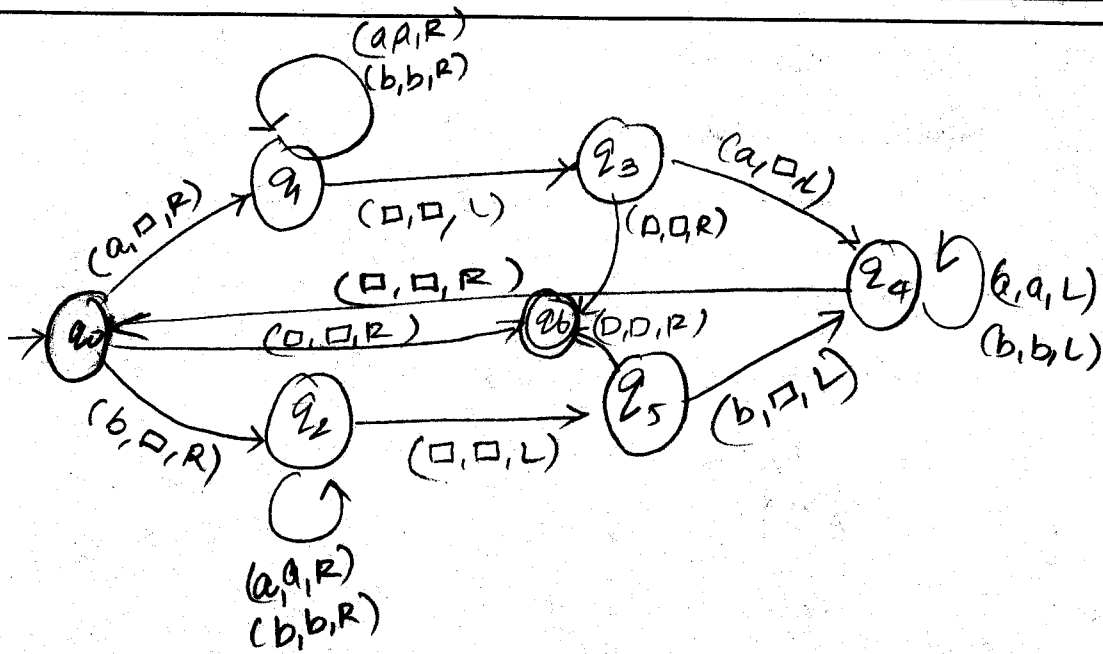

Using Machine as Transducer:

rejected strings of acceptor = \bar{L}

$$\hat{w} = f(w)$$

$$\boxed{q_0 w \xrightarrow{TM} q_f \hat{w}} \quad (q_f \in F)$$

→ Computable function: \leftrightarrow has TM.

→ q_i ends @ finite no. of steps

→ whatever the complexity.

\Rightarrow Algorithm, whatever the complexity.

* Addition with TM

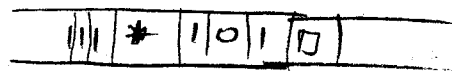

11 / 10 |

use unary NS:

Addition

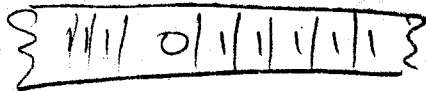

- skip till spl. char
- replace it with 1 & move to L
- till \square move to L & del last 1.

$$\delta(q_0, 1) = (q_0, 1, R)$$

$$\delta(q_0, 0) = (q_1, 1, R)$$

$$\delta(q_1, 1) = (q_1, 1, R)$$

$$\delta(q_1, \square) = (q_2, \square, L)$$

$$\delta(q_2, 1) = (q_3, 0, L)$$

$$\delta(q_3, 1) = (q_3, 1, L)$$

$$\delta(q_3, \square) = (q_f, \square, R)$$

Every TM has to have R/W @ beginning.

Ex. 7.4

Construct an npda for the language

$$L = \{w \in \{a,b\}^* : n_a(w) = n_b(w)\}$$

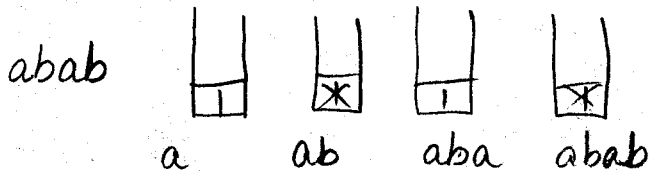

$$\delta(q_0, \lambda, z) = \{(q_f, z)\}$$

$$\delta(q_0, a, z) = \{(q_0, 1z)\}$$

$$\delta(q_0, b, z) = \{(q_0, 0z)\}$$

$$\delta(q_0, a, 1) = \{(q_0, 11)\}$$

$$\delta(q_0, b, 0) = \{(q_0, 00)\}$$

$$\delta(q_0, a, 0) = \{(q_0, \lambda)\}$$

$$\delta(q_0, b, 1) = \{(q_0, \lambda)\}$$

$M = (\dots)$

Test: $w = abab$

$$(q_0, \underline{abab}, \underline{z}) \vdash (q_0, \underline{bab}, \underline{1z}) \vdash (q_0, \underline{ab}, \underline{z}) \vdash (q_0, \underline{b}, \underline{1z}) \vdash$$

$$(q_0, \underline{\lambda}, \underline{z}) \vdash (q_f, \underline{\lambda}, \underline{z})$$

$\downarrow \in F$ accepted

$w = bbaa$

$$(q_0, \underline{bbaa}, \underline{z}) \vdash (q_0, \underline{baa}, \underline{0z}) \vdash (q_0, \underline{aa}, \underline{00z}) \vdash (q_0, \underline{a}, \underline{0z}) \vdash$$

$$(q_0, \underline{\lambda}, \underline{z}) \vdash (q_f, \underline{\lambda}, \underline{z})$$

$\downarrow \in F$ accepted.

Eq. 7.5 Construct an npda for $L = \{ww^R : w \in \{a,b\}^+\}$

$$\delta(q_0, a, z) = \{(q_0, az)\}$$

$$\delta(q_1, a, a) = \{(q_1, \lambda)\}$$

$$\delta(q_0, b, z) = \{(q_0, bz)\}$$

$$\delta(q_1, b, b) = \{(q_1, \lambda)\}$$

$$\delta(q_0, a, a) = \{(q_0, aa)\}$$

$$\delta(q_1, \lambda, z) = \{(q_f, z)\}$$

$$\delta(q_0, b, b) = \{(q_0, bb)\}$$

$$\delta(q_0, a, b) = \{(q_0, ab)\}$$

$$\delta(q_0, b, a) = \{(q_0, ba)\}$$

$$\delta(q_0, a, a) = \{(q_1, a)\}$$

$$\delta(q_0, b, b) = \{(q_1, b)\}$$

Test: $w = abba$

$$(q_0, abba, z) \vdash (q_0, bba, az) \vdash (q_0, ba, baz) \vdash$$

$$(q_1, ba, baz) \vdash (q_1, a, az) \vdash (q_1, \lambda, z) \vdash (q_f, \lambda, z)$$

↓
 $q_f \in F$

accepted

$w = abab$

$$(q_0, abab, z) \vdash (q_0, bab, az) \vdash (q_0, ab, baz) \vdash (q_0, b, abaz) \vdash (q_0, \lambda, babaz)$$

$\notin F$

→ rejected

$$M = (\{q_0, q_1, q_f\}, \{a, b\}, \{a, b, z\}, \delta, z, q_f)$$

② Construct npda's that accept the following regular languages

(a) $L_1 = L(aaa^*b)$

$$\delta(q_0, a, z) = \{(q_1, az)\}$$

$$\delta(q_1, a, a) = \{(q_2, aa)\}$$

$$\delta(q_2, a, a) = \{(q_2, aa)\}$$

$$\delta(q_2, b, a) = \{(q_f, ba)\}$$

$w = aab$

$$(q_0, \underline{a}ab, \underline{z}) \vdash (q_1, \underline{a}b, \underline{az}) \vdash (q_2, b, \underline{aaz})$$

$$\vdash (q_f, \underline{baaz})$$

↓
εF

accepted

(b) $L_2 = L(aab^*aba^*)$

$$\delta(q_0, a, z) = \{(q_1, az)\}$$

$$\delta(q_1, a, a) = \{(q_2, aa)\}$$

$$\delta(q_2, b, a) = \{(q_2, ba)\}$$

$$\delta(q_2, b, b) = \{(q_2, bb)\}$$

$$\delta(q_2, a, a) = \{(q_3, aa)\}$$

$$\delta(q_2, a, b) = \{(q_3, ab)\}$$

$$\delta(q_3, b, a) = \{(q_f, ba)\}$$

$$\delta(q_f, a, b) = \{(q_f, ab)\}$$

$$\delta(q_f, a, a) = \{(q_f, aa)\}$$

$$\delta(q_f, \lambda, b) = \{(q_f, b)\}$$

$$\delta(q_f, \lambda, a) = \{(q_f, a)\}$$

$w = aab$

$$(q_0, \underline{a}aab, \underline{z}) \vdash (q_1, \underline{a}ab, \underline{az}) \vdash (q_2, \underline{ab}, \underline{aa})$$

$$\vdash (q_3, \underline{b}, \underline{aaa}) \vdash (q_f, \underline{\lambda}, \underline{baaa}) \vdash$$

$$(q_f, \underline{\lambda}, \underline{baaa})$$

↓
εF

accepted

M(---)

(c) $L_1 \cup L_2$: $(aaa^*b) \cup (aab^*aba^*)$

$$\delta(q_0, a, z) = \delta(q_1, az)$$

$$\delta(q_1, a, a) = \delta(q_2, aa)$$

$$\delta(q_2, a, a) = \delta(q_3, aa) \quad a^+ \quad aaa^*$$

$$\delta(q_2, b, a) = \delta(q_4, ba), \delta(q_6, ba) \quad \boxed{aab \text{ final}} \quad \boxed{aaa^*b \text{ final}}$$

$$\delta(q_3, b, a) = \delta(q_4, ba)$$

$$\delta(q_3, b, b) = \delta(q_3, bb)$$

$$\delta(q_3, a, b) = \delta(q_4, ab)$$

$$\delta(q_4, b, a) = \delta(q_5, ba) \quad \boxed{aab^*ab \text{ final}}$$

$$\delta(q_5, a, a) = \delta(q_6, aa) \quad \boxed{aab^*aba^+ \text{ final}}$$

$$\delta(q_6, \lambda, z) = \delta(q_6, \lambda)$$

Test:
aabab:

$$\delta(q_0, \underline{a} \underline{a} \underline{b} \underline{a} \underline{b}, z) \vdash \delta(q_1, \underline{a} \underline{b} \underline{a} \underline{b}, \underline{a} z) \vdash \delta(q_2, \underline{b} \underline{a} \underline{b}, \underline{a} \underline{a} z) \vdash \delta(q_6, \underline{a} \underline{b} \underline{a} \underline{a} z)$$

$$\vdash \delta(q_4, \underline{a} \underline{b}, \underline{b} \underline{a} \underline{a} z) \vdash$$

store

npda \Leftrightarrow CFG

CFG \rightarrow npda

CFG \rightarrow GNF \rightarrow npda



A \rightarrow aX

$$\delta(q_0, \lambda, z) = (q, sz)$$

$$\delta(q, a, A) = (q, x)$$

$$\delta(q, \lambda, z) = (q_f, \lambda)$$

76
eg:

S \rightarrow asbb/a

S \rightarrow aSY/a
Y \rightarrow b } GNF

$$\delta(q_0, \lambda, z) = \{(q_1, sz)\}$$

$$\delta(q_1, a, s) = \{(q_2, sY), (q_1, \lambda)\}$$

$$\delta(q_2, \lambda, z) = \{(q_f, \lambda)\}$$

$$\delta(q_1, b, Y) = \{(q_1, \lambda)\}$$

M = (. . .)

Test

q: 77.

$$S \rightarrow aA$$

$$A \rightarrow aABC / bB / a$$

$$B \rightarrow b$$

$$C \rightarrow c$$

npda=?

$$\rightarrow \delta(q_0, \lambda, z) = \{(q_1, sz)\}$$

$$\delta(q_1, a, s) = \{(q_1, A)\}$$

$$\delta(q_1, a, A) = \{(q_1, ABC), (q_1, \lambda)\}$$

$$\delta(q_1, b, A) = \{(q_1, B)\}$$

$$\delta(q_1, b, B) = \{(q_1, \lambda)\}$$

$$\delta(q_1, c, C) = \{(q_1, \lambda)\}$$

$$\rightarrow \delta(q_1, \lambda, z) = \{(q_f, \lambda)\}$$

EXERCISES

- ①
- ②
- ③

$$S \rightarrow aABB / aAA$$

npda=?

$$A \rightarrow aBB / a$$

$$B \rightarrow bBB / A$$

$$\delta(q_0, \lambda, z) = \{(q_1, sz)\}$$

$$\delta(q_1, a, s) = \{(q_1, ABB), (q_1, AA)\}$$

$$\delta(q_1, a, A) = \{(q_1, BB), (q_1, \lambda)\}$$

$$\delta(q_1, b, B) = \{(q_1, BB), (q_1, A)\}$$

$$\delta(q_1, \lambda, z) = \{(q_f, \lambda)\}$$

(a)

find npda with 2 states for $L = \{a^n b^{n+1} \mid n \geq 0\}$

$$S \rightarrow aSb / b$$

QNF: $S \rightarrow aSY / b$
 $Y \rightarrow b$

$$\delta(q_0, \lambda, z) = \{(q_1, Sz)\}$$

$$\delta(q_1, a, S) = \{(q_1, SY)\}$$

$$\delta(q_1, b, Y) = \{(q_1, \lambda)\}$$

$$\delta(q_1, \lambda, z) = \{(q_b, \lambda)\}$$

$$\delta(q_1, b, S) = \{(q_1, \lambda)\}$$

$$\delta(q_0, \lambda, z) = \{(q_0, Sz_1)\}$$

$$\delta(q_0, a, S) = \{(q_0, SY)\}$$

$$\delta(q_0, b, S) = \{(q_0, \lambda)\}$$

$$\delta(q_0, b, Y) = \{(q_0, \lambda)\}$$

$$\delta(q_0, \lambda, z_1) = \{(q_b, \lambda)\}$$

(b)

find npda with 2 states that accepts $L = \{a^n b^{2n} \mid n \geq 1\}$

$$S \rightarrow aSbb / \lambda$$

QNF: $S \rightarrow aSbb / abb$

$$S \rightarrow aSBB / aBB$$

$$B \rightarrow b$$

$$\delta(q_0, \lambda, z) = \{(q_0, Sz_1)\}$$

$$\delta(q_0, a, S) = \{(q_0, SBB), (q_0, BB)\}$$

$$\delta(q_0, b, B) = \{(q_0, \lambda)\}$$

$$\delta(q_0, \lambda, z_1) = \{(q_b, \lambda)\}$$

CH # 7.3

Apda : DCFL

Apda

- ① $\delta(q, a, b)$ contains at most one element
- ② if $\delta(q, \lambda, b) \neq \emptyset$
then $\delta(q, c, b) = \emptyset \quad \forall c \in \Sigma$

Eg: 7.10

$L = \{a^n b^n : n \geq 0\}$ is DCFL.
Dpda = ?

$$\delta(q_0, a, 0) = \{(q_1, 10)\}$$

$$\delta(q_1, a, 1) = \{(q_1, 11)\}$$

$$\delta(q_1, b, 1) = \{(q_2, \lambda)\}$$

$$\delta(q_2, b, 1) = \{(q_2, \lambda)\}$$

$$\delta(q_2, \lambda, 0) = \{(q_0, \lambda)\}$$

$q_0 \in F$

*)

$L = \{a^n b^n : n \geq 0\} \cup \{a\}$

Dpda = ?

$$\delta(q_0, a, z) = (q_1, az)$$

$$\delta(q_1, a, a) = (q_1, aa)$$

$$\delta(q_1, b, a) = (q_1, \lambda)$$

$$\delta(q_1, \lambda, z) = (q_1, \lambda)$$

$$\delta(q_1, a, a) = (q_1, aa)$$

$$\delta(q_2, b, a) = (q_2, \lambda)$$

$$\delta(q_2, b, a) = (q_2, \lambda)$$

$\{q_0, q_1, q_2\} \in F$

① ST. $L = \{a^n b^m : n \geq 0\}$ is a DCFL. abb

$$\delta(q_0, \lambda, z) = (q_0, \lambda)$$

$$\delta(q_0, a, z) = (q_1, \lambda z)$$

$$\delta(q_1, a, \lambda) = (q_1, \lambda)$$

$$\delta(q_1, b, \lambda) = (q_1, \lambda)$$

$$\delta(q_1, \lambda, z) = (q_0, \lambda z)$$

dpda

∴ DCFL

Test abb: accepted

$$\delta(q_0, \underline{a} \underline{b} \underline{b}, z) \vdash \delta(q_1, \underline{b} \underline{b}, \lambda z) \vdash \delta(q_1, \underline{b}, \lambda z) \vdash \delta(q_1, \lambda, \lambda z) \vdash (q_0, \lambda z)$$

aabbbb: accepted

$$\delta(q_0, \underline{a} \underline{a} \underline{b} \underline{b} \underline{b} \underline{b}, z) \vdash \delta(q_1, \underline{a} \underline{b} \underline{b}, \lambda z) \vdash \delta(q_1, \underline{b} \underline{b}, \lambda \lambda z) \vdash \delta(q_1, \underline{b} \underline{b}, \lambda \lambda \lambda z) \vdash \dots$$

③ $L = \{a^n b^n : n \geq 1\} \cup \{b\}$ DCFL?

$$\delta(q_0, a, z) = (q_1, \lambda z)$$

$$\delta(q_0, b, z) = (q_0, \lambda z)$$

$$\delta(q_1, a, \lambda) = (q_1, \lambda)$$

$$\delta(q_1, b, \lambda) = (q_1, \lambda)$$

$$\delta(q_1, \lambda, z) = (q_0, \lambda z)$$

= dpda

∴ DCFL ✓

5

8

$L = \{a^n b^m : n=m \text{ or } n=m+2\}$ is DCFL?

$\{a^n b^n\} \cup \{a^{n+2} b^n\}$

9

WCCO^R

↓

start matching.

Properties of CFL

ST $L = \{a^n b^n c^n : n \geq 0\}$ is not context free.

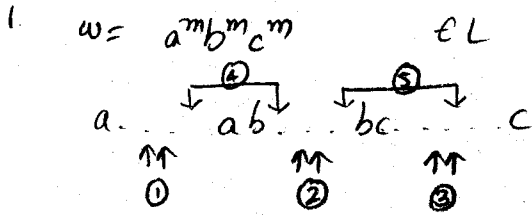

2.1 $v = a$
 $y = a$

$w_i = a^{m+2i-2} b^m c^m$

$i > 1 \Rightarrow m+2i-2 > m$

$w_i \notin L$

$\therefore n_a(w_i) \neq n_b(w_i)$
 $\neq n_c(w_i)$

$w_i \notin L$

2.2 $v = b$
 $y = b$

2.3 $v = c$
 $y = c$

2.4 $v = a$
 $y = b$

2.5 $v = b$
 $y = c$

$w_i = a^{m+i-1} b^{m+i-1} c^m$

$i > 1 \Rightarrow m+i-1 > m$

$\Rightarrow n_a(w_i) \neq n_c(w_i)$

$n_b(w_i) \neq n_c(w_i)$

$w_i \notin L$

similar cases

similar case

\therefore as Pumping lemma fails, L is not a CFL.

Ex: # 8.2

$L = \{ww : w \in \{a,b\}^*\}$ CFL?

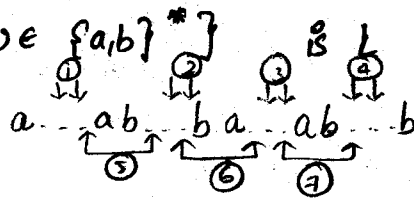

1. $w = a^n b^n a^n b^n$

2.1 $w_i = a^{n+2i-2} b^n a^n b^n$

$i > 1 \Rightarrow n+2i-2 > n$

$w_i \notin L$

$v = a$
 $y = a$ {first w}

2.2 $v = b, y = b$
2.3 $v = a, y = a$
2.4 $v = b, y = b$

similar cases

2.5 $v = a, y = b$

$w_i = a^{n+i-1} b^{n+i-1} a^n b^n$

$i > 1 \Rightarrow n_a(\text{first } w) >$

$n_a(\text{second } w)$

$\therefore w_i \notin L$

2.6 $v = b, y = c$

2.7 $v = a, y = b$

similar case

L is not CFL as PL fails.

Ex. 8.3 ST. $L = \{a^n : n \geq 0\}$ is not context free.

1. $w = a^m \in L$

2. $v = a^k$

$y = a^l$

$w_p = a^{(m-(k+l)+2)!}$

$k+l < m : m-(k+l) > 0$

$\therefore m-(k+l) > m!$

\therefore not CFL.

Ex. 8.4 ST $L = \{a^n b^i : n = j^2\}$ is not CFL.

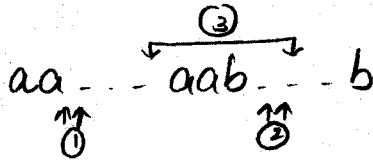

1. $w = a^{m^2} b^m \in L$

2.1 $v = a$

$y = a$

$w_p = a^{m^2+2i-1} b^m$

$i > 1 \Rightarrow m^2+2i-1 > m^2$

$\therefore w_p \notin L$

(\approx 2.2 $v=b, y=b$)

2.3 $v=a$

$y=b$

$w_p = a^{m^2+i-1} b^{m+i-1}$

$i=0 : m^2-1 \neq (m-1)^2$

$w_p \notin L$

L is not CFL

4) $L = \{a^m b^j a^j b^n : m, j > 0\}$ is CFG or not?

$\delta(q_0, a, z) = \{(q_0, az)\}$

$\delta(q_0, a, a) = \{(q_0, aa)\}$

$\delta(q_0, b, a) = \{(q_1, ba)\}$

$\delta(q_1, b, b) = \{(q_1, bb)\}$

$\delta(q_1, a, b) = \{(q_2, \lambda)\}$

$\delta(q_2, a, b) = \{(q_2, \lambda)\}$

$\delta(q_2, b, a) = \{(q_3, \lambda)\}$

$\delta(q_3, b, a) = \{(q_3, \lambda)\}$

$\delta(q_3, \lambda, z) = \{(q_6, \lambda)\}$

(H48.1)

$$L = \{ a^n b^m c^j : n \leq j \}$$

1. $w = a^m b^m c^{m+1}$

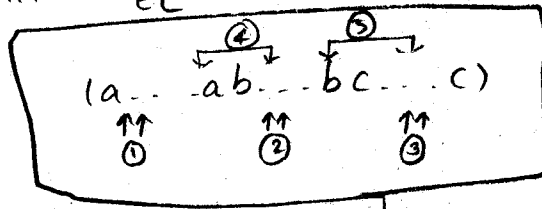

2.1

$$\begin{aligned} x &= a \\ y &= a \end{aligned}$$

$$w_i = a^{m+2i-2} b^m c^{m+1}$$

$$i > 1 \quad m+2i-2 > m$$

$$\Rightarrow n_a(w) \neq n_b(w)$$

$$w_i \notin L$$

2.2

similar cases

2.3. $\begin{aligned} x &= c \\ y &= c \end{aligned}$

$$w_i = a^m b^m c^{m+2i-2}$$

$$i = 0 \quad m-1 \leq m$$

$$w_i \notin L$$

2.4. $\begin{aligned} x &= a \\ y &= b \end{aligned}$

$$w_i = a^{m+i-1} b^{m+i-1} c^{m+1}$$

$$i > 2 \Rightarrow m+i-1 > m+1$$

$$\therefore w_i \notin L$$

$$n_c(w) \neq n_a(w) > n_b(w)$$

2.5

$\therefore L \notin CFL$

EXERCISES

②

ST $L = \{ a^n : n \text{ is a prime no.} \}$ is not CFL.

1. $w = a^m$

m is prime: $\in L$

2.



$$\begin{aligned} x &= a \\ y &= a \end{aligned}$$

$$w_i = a^{m+2i-2}$$

$$i = 0 \quad m+2i-2 = m-2$$

$m-2$ is not prime

$\left. \begin{aligned} i > 0 \\ i < 0 \end{aligned} \right\} m+2i-2$ not necessarily prime

\therefore PL fails \Rightarrow NOT CFL

⑤ Is $L = \{a^n b^m : n=2^m\}$ CFL?

1. $w = a^{2^m} b^m \in L$

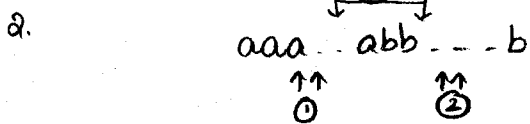

2.1 $\theta = a$
 $\gamma = a$
 $w_i = a^{2^m + 2^i - 2} b^m$

2.2 similar for $\gamma = b$

2.3 $\theta = a$
 $\gamma = b$
 $w_i = a^{2^m + i - 1} b^{m+i-1}$

$2^m + 2^i - 2$

$i=0 : 2^m - 2 \neq 2^m$

ie. $\text{pow}(a) \neq 2^m$

$\therefore w_i \notin L$

$i=0 : a^{2^m-1} b^{m-1}$

$2^{m-1} = 2^m - 2 = 2^{m-1} - 1$

$2^{m-1} > 2^m - 1$

ie. $\text{pow}(a) \neq 2^m$

$\therefore w \notin L$

is not CFL:

⑦ a) $L = \{a^n b^j : n \leq j^2\}$

$w = a^{j^2} b^j$

not CFL

b) $L = \{a^n b^j : n \geq (j-1)^3\}$

$w = a^{(j-1)^3} b^j$

not CFG

c) $n_a(w) \geq n_b(w) < n_c(w)$

$a^n b^{n+1} c^{n+2}$

⑧ CFL or not?

(a) $L = \{a^n w w^R a^n : n > 0; w \in \{ab\}^*\}$

$w w^R : \text{CFL}$
 $a^n : \text{CFL}$ } CFL closed under concatenation $\Rightarrow \text{CFL}$

$\delta(q_2, a, b) = \{(q_3, \lambda)\}$

$\delta(q_3, a, a) = \{(q_3, \lambda)\}$

$\delta(q_2, \lambda, \lambda) = \{(q_1, \lambda)\}$

$\delta(q_0, a, \lambda) = \{(q_0, a\lambda), (q_1, a\lambda)\}$

$\delta(q_0, a, a) = \{(q_0, aa), (q_1, aa)\}$

$\delta(q_1, a, a) = \{(q_1, aa)\}$

$\delta(q_1, b, a) = \{(q_1, ba)\}$

$\delta(q_1, a, b) = \{(q_1, ab), (q_2, \lambda)\}$

$\delta(q_1, b, b) = \{(q_1, bb), (q_2, \lambda)\}$

$\delta(q_2, a, a) = \{(q_2, \lambda)\}$

$\delta(q_2, b, b) = \{(q_2, \lambda)\}$

CH# 8.1

⑥
 $L = \{a^n b^j a^n b^j : n \geq 0, j \geq 0\}$

not CFG

1. $w = a^m b^k a^m b^k \in L$

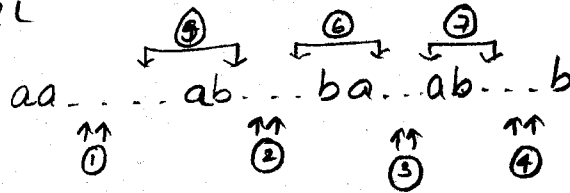

2.1 $x = a$
 $y = a$

2.2
2.3
2.4

 $w_i = a^{m+2i-2} b^k a^m b^k$

2.5 $x = a$
 $y = b$

2.6
2.7

 $w_i = a^{m+i-1} b^{m+i-1} a^m b^m$

$i > 0 : m+2i-2 > m$

$i = 0 : m-1 \neq m$

$w_i \notin L$

$w_i \notin L$

PL fails \Rightarrow NOT CFL

⑦ $L = \{a^n b^j a^j b^n : n \geq 0, j \geq 0\}$

$a^n b^j$

 $\left\{ \begin{array}{l} \delta(q_0, a, z) = \{ (q_0, az) \} \\ \delta(q_0, a, a) = \{ (q_0, aa) \} \\ \delta(q_0, b, a) = \{ (q_1, ba) \} \end{array} \right.$

$\delta(q_0, b, z) = \delta(q_1, bz)$

$a^0 b^j$

$\delta(q_1, b, b) = \{ (q_2, bb) (q_3, \lambda) \}$

$b^j a^j$

$\delta(q_2, a, b) = \{ (q_1, \lambda) \}$

$b^0 a^0$

$\delta(q_2, b, b) = \{ (q_3, \lambda) \}$

$\delta(q_3, b, b) = \{ (q_3, \lambda) \}$

$\delta(q_3, \lambda, z) = \{ (q_1, \lambda) \}$

$a^n \times b^n$

$\delta(q_0, \lambda, z) = \{ (q_0, \lambda) \} \rightarrow \lambda \in L(G)$

\therefore CFL

(d)

$$L = \{ a^n b^j a^k b^l : n+j < k+l \}$$

1. $w = a^n b^n a^m b^m$ $n < m$

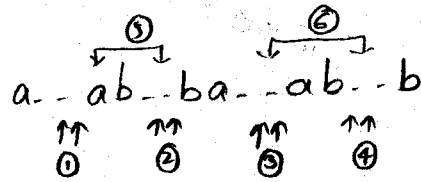

2.2
2.3
2.4

2.1

$$U = a$$
$$y = a$$

$$w_i = a^{n+2i-2} b^n a^m b^m$$

$$i > 0 \quad n+2i > m$$

but $n < m$

$\therefore w_i \notin L$

2.5

$$U = a$$
$$y = b$$

$$w_i = a^{n+i-1} b^{n+i-1} a^m b^m$$

POW(LHS)

POW(RHS)

$$2n+2i-2 \quad : \quad 2m$$

$$\boxed{n+i-1} \quad : \quad \boxed{m}$$

$$n < m$$

$$i > 0 \quad n+i > m$$

$w_i \notin L$

is PL fails, NOT CFL

(e)

$$L = \{ a^n b^j a^k b^l : n \leq k, j \leq l \}$$

NOT CFL

(f)

$$L = \{ a^n b^n c^j : n \leq j \}$$

NOT CFL

(g)

$$L = \{ w \in \{a,b,c\}^* : n_a(w) = n_b(w) = 2n_c(w) \}$$

NOT CFL.

CFL closed under \cup union
 \cdot concatenation
 \rightarrow $*$ Star Closure.

$RL \cap CFL = CFL$

NOT closed under } \rightarrow Intersection \cap
 \rightarrow Complement \bar{A} :

Ex: 8.7 ST $L = \{a^n b^n : n \geq 0, n \neq 100\}$ is CFL.

$L_2 = \{a^n b^n : n \geq 0\}$

$L_1 = \{a^n b^n : n = 100\}$

$L_1 = \{a^{100} b^{100}\} \rightarrow$ Regular

regular languages are closed under complement
 $\therefore L_1$ is also regular.

$L = L_2 \cap \bar{L}_1 = \{a^n b^n : n \neq 100, n \geq 0\}$
 $\downarrow \quad \downarrow$
 CFL RL

$\therefore L$ is a CFL.

Ex: 8.8 ST $L = \{[a^n b^n c^n]^* : n_a(w) = n_b(w) = n_c(w)\}$ is not CFL.

PL fails: also: $L_1 = (a^* b^* c^*) \rightarrow$ Regular

we know $L_2 \{a^n b^n c^n\}$ is NOT CFL.

$L \cap L_1 = L_2$
 $\downarrow \quad \downarrow \quad \downarrow$
 Regular NOT CFL

Case (i) L is CFL $\Rightarrow L_2$ should be CFL, but is not \Rightarrow L is NOT CFL
 Case (ii) L is not CFL $\Rightarrow L$ is not CFL. True.

Is Empty / Is not Empty

$N \rightarrow \epsilon$
 $N \rightarrow X$

Eq:

$S \rightarrow XY$ $X \rightarrow AX$ $X \rightarrow AA$ $A \rightarrow a$ $Y \rightarrow BY$ $Y \rightarrow BB$ $B \rightarrow b$	$S \rightarrow XY$ $X \rightarrow AX$ $X \rightarrow aa$ $Y \rightarrow BY$ $Y \rightarrow bb$	$S \rightarrow aabb$ $L(G)$ NOT empty
------------------------------------------------------------------------------------------------------------------------------------------------------	--------------------------------------------------------------------------------------------------------------------------------------------------------	----------------------------------------------

Eq:

$S \rightarrow XY$ $X \rightarrow AX$ $A \rightarrow a$ $Y \rightarrow BY$ $Y \rightarrow BB$ $B \rightarrow b$	$S \rightarrow XY$ $X \rightarrow AX$ $Y \rightarrow BY$ $Y \rightarrow bb$	$S \rightarrow Xbb$ $X \rightarrow aX$ $L(G)$ Is Empty.
--------------------------------------------------------------------------------------------------------------------------------	------------------------------------------------------------------------------------------------------------	----------------------------------------------------------------------

Eq*:

$S \rightarrow XS / YZ$
 $X \rightarrow YX$
 $Y \rightarrow YZ$
 $Z \rightarrow XX$
 $X \rightarrow A$
 $Z \rightarrow SX$

Is Empty

Eq*:

$S \rightarrow AB$ $A \rightarrow BS$ $B \rightarrow AS$ $A \rightarrow CC$ $B \rightarrow CC$ $C \rightarrow SS$ $A \rightarrow a/b$	$S \rightarrow aB/bB$ $B \rightarrow aaS/bbS/abS/baS$ $B \rightarrow bb/bbb/bbbb$	$S \rightarrow abb/abbb/abbbb/bbb/bbbb/bbbbb$ $L(G)$ NOT empty
-----------------------------------------------------------------------------------------------------------------------------------------------------------------------------------------------------------------------------------------------------------------------	---------------------------------------------------------------------------------------------------------------	-----------------------------------------------------------------------

CFL * CFL₂ not closed
 RL - RL is closed

ST $L_1 - L_2 = CFL$
 if $L_1 = CFL$ &
 $L_2 = RL$.

$L_1 - L_2$: assume closed under difference. - ①

$$L_1 - L_2 = L_1 \cap \bar{L}_2$$

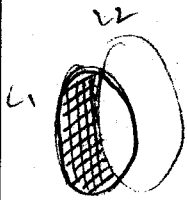

① \Rightarrow LHS is CFL

RHS is not CFL as languages are not closed under concatenation

\therefore assumption of ① is wrong

\therefore CFL not closed under '-'

$$L_1 = CFL$$

$$L_2 = RL$$

$$L_1 - L_2 = L_1 \cap \bar{L}_2$$

$L_1 \cap \bar{L}_2$: context free language.
 $\downarrow \quad \downarrow$
 CFL RL

\Rightarrow If $L_1: CFL, L_2: RL$ then closed under difference.

② \supset CFL
 ST not closed under \cup & \cap

DCFL \Rightarrow DPDA

$L_1, L_2 \in DCFL$

$L = L_1 \cup L_2 \Rightarrow \begin{matrix} S \rightarrow S_1 / S_2 \\ S \rightarrow \epsilon \end{matrix} \rightarrow$ non-deterministic

$$L_1 \cap L_2 \Rightarrow \overline{\overline{L_1} \cup \overline{L_2}} = \overline{L} \text{ not DCFL}$$

(18)

SI $L = \{w \in \{a,b\}^* : n_a(w) = n_b(w) : w \text{ doesn't contain substring } aab\}$

$$L_2 = (a+b)^* aab (a+b)^*$$

↓
Regular language $\Rightarrow \bar{L}_2$ also RL

$$L_1 = \{ \{a,b\}^* : n_a(w) = n_b(w) \}$$

we know NOT CFL
(PL fails)

$a^m b^k a^l b^j$
$(m+l = k+j)$

$$L \cap \bar{L}_2 = L$$

↓
RL

Case (i) L is CFL $\Rightarrow L_1$ is CFL / not true

Case (ii) L is NOT CFL $\Rightarrow L_1$ is NOT CFL / true

$\therefore L$ is not CFL